Small general frequency converter

Operating Instruction

220V level 0.4kW-3.0kW

400V level 0.4kW-7.5kW

■ Please read this manual carefully and understand the contents for correct installation and use.

■ Please give this manual to the final user and keep it properly.

■ The technical specifications of this product may change without notice.

2RI20220408-12.0 Version A

English

Start Date: April 08, 2022

Document Number: XM-H0126

V1.7

Solemn statement

Thank you for using the frequency converter. Before use, must read this manual carefully, and use it after you are familiar with the safety precautions of this product.

Safety Precautions:

1. Before wiring, please confirm whether the input power is off.
2. For wiring work, please invite professional electrical engineer to work.
3. The ground terminal must be grounded.
4. After the wiring of the emergency stop circuit is completed, must check whether the action is effective.
5. The output wire of the frequency converter must not be connected to the housing, and the output wire should not be short-circuited.
6. Please confirm whether the voltage of the AC main circuit power supply is consistent with the rated voltage of the frequency converter.
7. Do not perform voltage withstand test on the frequency converter.
8. Please connect the braking resistor according to the wiring diagram.
9. Do not connect the power cord to the output U, V, W terminals.
10. Do not connect the contactor to the output circuit.
11. Be sure to install the protective cover before powering on. When removing the cover, must disconnect the power supply.
12. Select the frequency converter with the reset and retry function, please do not approach the mechanical equipment. It will restart suddenly when the alarm stops.
13. After confirming that the running signal is cut off, the alarm can be reset. If the alarm is reset in the running signal state, the frequency converter may start suddenly.
14. Do not touch the terminals of the frequency converter. There is high voltage on the terminals, which is very dangerous.
15. Do not change the wiring and terminal disassembly during power-on.
16. Cut off the main circuit power supply before inspection and maintenance.
17. Do not modify the frequency converter without authorization.

1.Parameters List

Rated data of frequency converter			
Model	Power	Power supply	Output current (A)
0.75G1-220V	0.75KW	Single phase alternating 220V-240V 50Hz/60Hz	4.5
1.5G1-220V	1.5KW		7
2.2G1-220V	2.2KW		10
0.75G3-380V	0.75KW	Three-phase alternating 380V-440V 50Hz/60Hz	2.5
1.5G3-380V	1.5KW		3.7
2.2G3-380V	2.2KW		5
4.0G3-380V	4.0KW		9
5.5G3-380V	5.5KW		13
7.5G3-380V	7.5KW		17

2.Product Size

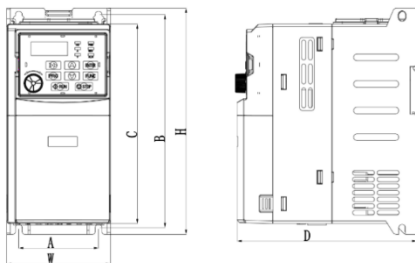

Product size of frequency converter						
	H	W	D	A	B	C
0.75G1-220V	170	78	135	60	160	150
1.5G1-220V	170	78	135	60	160	150
2.2G1-220V	170	78 <td 135	60	160	150	
0.75G3-380V	170	78	135	60	160	150
1.5G3-380V	170	78	135	60	160	150
2.2G3-380V	170	78	135	60	160	150
4.0G3-380V	212	95	151	78	200	180
5.5G3-380V	212	95	151	78	200	180
7.5G3-380V	240	140	181	129	230	240

3.Installation and wiring

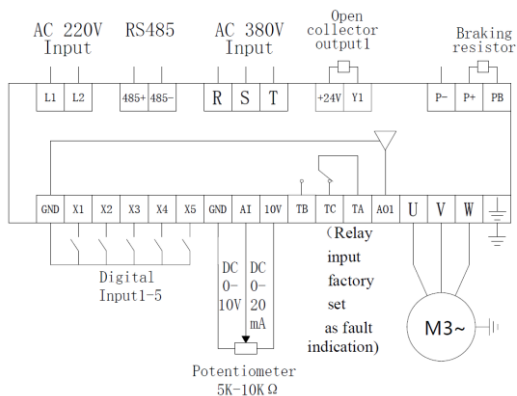

Usage description of wire terminal

Terminal	Usage	Setting and Description
R、S、T	Power supply of frequency converter: 380V model connects to R, S, T 220V model connect to R, S or R, T (determined according to terminal label)	The front end of the input power supply of the frequency converter should use an air switch as an overcurrent protection device. If a leakage protection switch is added, in order to prevent the leakage switch from malfunctioning, please choose a device with a sensitivity of 200mA and action time more than 100ms
U、V、W	Frequency converter output which is connected to the motor	In order to reduce the leakage current, the motor connection line should not exceed 50 meters.
	Grounding	The frequency converter must be well grounded.
GND	Signal common terminal	Zero potential of digital signal
X1	Digital input X1	Set by parameter F2.13, the factory default is forward
X2	Digital input X2	Set by parameter F2.14, the factory default is reverse
X3	Digital input X3	Set by parameter F2.15, the factory default is the first stage of multi-speed
X4	Digital input X4	Set by parameter F2.16, the factory default is the second stage of multi-speed
X5	Digital input X5	Set by parameter F2.17, the factory default is external reset signal
AI	0-10V signal input/4-20mA analog amount input	0-10V, input resistance: >50kΩ/4-20mA input resistance: 100 Ω
+10V	Frequency set the potentiometer power supply	+10V, 10mA is largest
AO1	analog amount output signal	Set by parameter F2.10
TA1、TB1、TC1	Relay output	Set by parameter F2.20 Contact rating: 250V/3A DC 24V/2A

Terminal	Usage	Setting and Description
RS485+	485 communication	Debug through F6 group parameters, standard RS485 interface
RS485-	485 communication	Debug through F6 group parameters, standard RS485 interface
Y1	Open collector output 1	4-20mA Input resistance: 100Ω
+24V	Open collector output power supply	+24V,10mA is the largest

4. Commissioning

① Operation panel and method

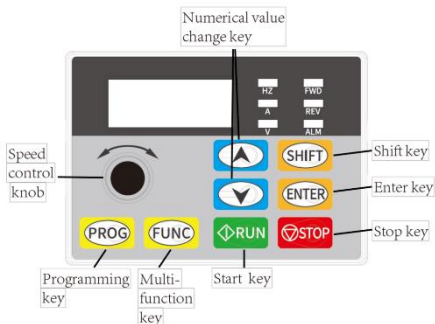

Note: After the frequency converter is powered on, the running panel will display 50.0 (output frequency)

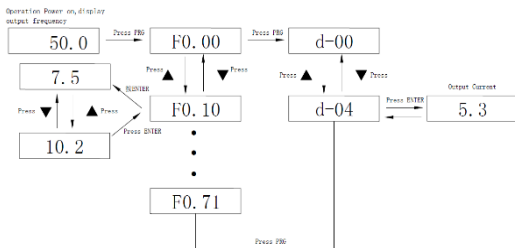

Method of return to the original interface after setting the parameters:

1. After power off, power on again.
2. Select parameter d-00, then press PRG key.
3. Long press the SET button for 3 seconds

② Frequency converter running command method setting

The frequency converter operation command mode is set by parameter F0.02: there are three types: start and stop controlled by panel, terminal and communication (optional):

(1) Panel control start and stop: (factory default is panel start and stop F0.02=0)

To use the panel to control the start and stop of the frequency converter, please press the green button on the panel to start and the red button to stop. The frequency converter will start forward by default, and the forward and reverse must be set through the input terminals X1-X5 (set to 4 for reverse).

(2) Terminal start and stop:

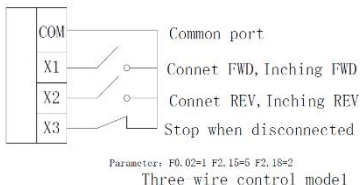
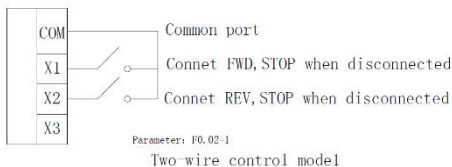

③ Selection of frequency converter setting mode

The frequency setting mode of the frequency converter is set by parameter F0.03. When F0.03=0, the operating frequency is set by the Panel potentiometer; when F0.02=3, the operating frequency is inputted by AI (0-10V can be connected to the potentiometer); when changing J5 jumper cap position, the operating frequency is inputted by AI (4-20mA); when F0.03=2, which is controlled by external terminals (the switch amount value is set to frequency increase/decrease).

5. Parameters List

Parameter	Name	Factory Default	Predetermined Area	Content
F0 Group- Basic operating parameters				
F0.00	Function macro definition (Reserve temporarily)	0	0~9	0: General mode 1: Mode of supply water at constant pressure with a single pump 2: Mode of supply water at constant pressure with one driven two 3: Knapsack intelligent small pump mode 4: Engraving machine mode 5: Security scene application mode 6: Start scenario application with high torque mode 7: Fast start-stop scenario application mode 8: Automatic energy-saving scenarios application mode 9: Custom mode (Please refer to custom macro parameter group, which can support up to 16 parameter application combinations)
F0.01	Motor control method	1	0~4	0: VF control 1: Advanced VF control 2: Simple vector control 3: Senior vector control 4: Torque control
F0.02	Run command channel selection	0	0~2	0: The panel runs the command 1: The terminal runs the command 2: The communication runs command channels
F0.03	Frequency setting selection	0	0~7	0: Panel potentiometer 1: Digital setting 1, adjust by operating ▲/▼ keys on the panel 2: Digital setting 2, adjust by terminals UP/DOWN

Parameter	Name	Factory Default	Predetermined Area	Content
F0.03	Frequency setting selection	0	0~7	3: AI simulation given (0 ~ 10V)/ (0~20 mA) 4: Combination given 5: Retain 6: Communication given 7: Retain Note: When selecting the combination given, select the mode of combination given mode in F1.15.
F0.04	Maximum output frequency	50.0 Hz	50.0 ~999 Hz	The maximum output frequency is the highest output frequency allowed by the frequency converter and the reference for the acceleration/ deceleration setting.
F0.05	Upper limit frequency	50.0 Hz	50.0 ~999 Hz	The operating frequency cannot exceed this frequency
F0.06	Low limit frequency	0.0 Hz	0.0~Upper limit frequency	The operating frequency cannot be lower than this frequency
F0.07	The processing at the lower limit frequency	0	0~2	0: Run at zero speed 1: Run at lower limit frequency 2: Stop
F0.08	Operation frequency digital setting	10.0 Hz	0~upper limit frequency	The set value is initial value of frequency digital setting
F0.09	Digital frequency control	0000	0000~2111	Ones place: Store at power off 0: Store 1: Do not store Tens place: Keep state at downtime 0: Keep 1: Do not keep Hundreds place: UP/DOWN negative frequency regulation 0: Invalid 1: Valid Thousands place: PID and PLC frequency overlay selection 0: Invalid 1: F0.03+PID 2: F0.03+PLC

Parameter	Name	Factory Default	Predefined Area	Content
F0.10	Acceleration time	Device setting 0.1~999.9 S 0.4~4.0 KW	7.5 S 5.5~7.5 KW 15.0 S	Time required for the frequency converter to accelerate from zero frequency to the maximum output frequency
F0.11	Deceleration time	Device setting 0.1~999.9 S 0.4~4.0 KW	7.5 S 5.5~7.5 KW 15.0 S	Time required for the frequency converter to decelerate from maximum output frequency to zero frequency
F0.12	Running direction setting	0	0~2	0: Forward 1: Reverse 2: Ban reversing
F0.13	V/F curve setting	0	0~2	0: Linea curve 1: Square curve 2: Multipoint VF curve
F0.14	Torque lift amount	Device setting	0.0~30.0%	Manual torque lift; this value setting is percent relative to the motor rating voltage
F0.15	Cut-off frequency of torque lift	15.0 Hz	0.0~50.0 Hz	This setting is the lifting cut-off frequency point of manual torque lifting
F0.16	Carrier frequency setting	Device setting	2.0~16 kHz 0.4~3.0 kW 4.0 kHz 4.0~7.5 kW 3.0 kHz	Increase the carrier frequency can reduce the noise, but which will increase the heat of frequency converter
F0.17	V/F frequency value F1	12.5 Hz	0.1~frequency Value F2	
F0.18	V/F voltage value V1	25.0%	0.0~ Voltage value V2	
F0.19	V/F frequency value F2	25.0 Hz	Frequency value F1 ~ Frequency value F3	

F0.20	V/F Voltage value V ₂	50%	Voltage value V ₁ ~ Voltage value V ₃	
F0.21	V/F frequency value F ₃	37.5 Hz	Frequency value F ₂ ~ Motor rated power [F4.03]	
F0.22	V/F Voltage value V ₃	75%	Voltage value V ₂ ~100.0% (Motor rated voltage [F4.00])	
F0.23	User password	0	0~9999	Set any non-zero number and wait 3 minutes or power down before it takes effect
F0.24	Frequency display resolution selection	0	0~1	0: 0.1 Hz 1: 1 Hz Note: When you are setting this parameter, must check the maximum output frequency (F0.04), upper limit frequency (F0.05), motor rated frequency
				other frequency-related parameters
Group F1 - auxiliary operating parameters				
F1.00	Dc braking mode when starting	00	0000~0011	Ones place: Start type 0: Start from the starting frequency 1: First dc braking and then start from the starting frequency Tens place: Power failure or abnormal restart mode 0: Invalid 1: Start from the starting frequency Hundreds place: Reserve Thousands place: Reserve
F1.01	Dc braking start voltage	1.0 Hz	0.0~500 Hz	

F1.02	Dc braking voltage when starting	0.0 %	0.0~50.0% multiply by rated voltage	
F1.03	Start dc braking time	0.0 s	0.0~30.0 s	
F1.04	Stop mode	0	0~1	0: Slow down to stop 1: Stop freely
F1.05	Starting frequency of stop DC braking	0.0 Hz	0.0~Upper limit frequency	
F1.06	Stop DC braking voltage	0.0%	0.0~50.0% multiply by motor rated voltage	
F1.07	Stop DC braking time	0.0 s	0.0~30.0 s	
F1.08	Waiting time of stop DC braking	0.00 s	0.00~99.99 s	
F1.09	Frequency setting of forward jog	10.0 Hz	0.0 ~ 50HZ	Set the frequency of forward and reverse jog
F1.10	Frequency setting of reverse jog			
F1.11	Jog acceleration time	Device setting	0.1~999.9 s 0.4~4.0 kW 10.0 s 5.5~7.5 kW 15.0 s	Set the jog acceleration and deceleration time
F1.12	Jog deceleration time			
F1.13	Hopping frequency	0.0 Hz	0.0~Upper limit frequency	The frequency converter can avoid the mechanical resonance point of load by setting the jumping frequency
F1.14	Hopping range	0.0 Hz	0.0~10.0 Hz	and range.

Parameter	Name	Factory Default	Predefined Area	Content
F1.15	Combination of frequency setting method	0	0~8	0: Potentiometer + digital frequency 1 1: Potentiometer + digital frequency 2 2: Potentiometer + AI 3: Digital frequency 1+AI 4: Digital frequency 2+AI 5: Digital frequency 1+multi-speed 6: Digital frequency 2+ multi-speed 7: Potentiometer + multi-speed 8:AI+PLC (Same direction superposition)
F1.16	Programmable operation control (Simple PLC operation)	0000	0000~1221	Ones place: PLC enable control 0: Invalid 1: Valid Tens place: Operation mode selection 0: Single cycle 1: Continuous cycle 2: Keep the final value after a single cycle Hundreds place: Start mode 0 : Restart from the first stage 1 : Start from the stage of stop (fault) moment 2 : Start from the stage and frequency of stop (fault) moment Thousands place: Power down storage options 0: Do not store 1: Store
F1.17	Multi-speed frequency 1	5.0 Hz	Lower limit frequency~Upper limit frequency	Set the frequency in velocity period 1
F1.18	Multi-speed frequency 2	10.0 Hz	Lower limit frequency ~Upper limit frequency	Set the frequency in velocity period 2
F1.19	Multi-speed frequency 3	15.0 Hz	Lower limit frequency ~Upper limit frequency	Set the frequency in velocity period 3

Parameter	Name	Factory Default	Predetermined Area	Content
F1.20	Multi-speed frequency 4	20.0 Hz	Lower limit frequency ~ Upper limit frequency	Set the frequency in velocity period 4
F1.21	Multi-speed frequency 5	25.0 Hz	Lower limit frequency ~ Upper limit frequency	Set the frequency in velocity period 5
F1.22	Multi-speed frequency 6	37.5 Hz	Lower limit frequency ~ Upper limit frequency	Set the frequency in velocity period 6
P1.23	Multi-speed frequency	50.0 Hz	Lower limit frequency ~ Upper limit frequency	Set the frequency in velocity period 7
F1.24	Running time of stage 1	10.0 s	0.0~999.9 s	Set the running time of stage 1 (Unit is chosen by [F1.35] and defaults to second)
P1.25	Running time of stage 2	10.0 s	0.0~999.9 s	Set the running time of stage 2 (Unit is chosen by [F1.35] and defaults to second)
F1.26	Running time of stage 3	10.0 s	0.0~999.9 s	Set the running time of stage 3 (Unit is chosen by [F1.35] and defaults to second)
F1.27	Running time of stage 4	10.0 s	0.0~999.9 s	Set the running time of stage 4 (unit is chosen by [F1.35] and defaults to second)
F1.28	Running time of stage 5	10.0 s	0.0~999.9 s	Set the running time of stage 5 (Unit is chosen by [F1.35] and defaults to second)
F1.29	Running time of stage 6	10.0 s	0.0~999.9 s	Set the running time of stage 6 (Unit is chosen by [F1.35] and defaults to second)
F1.30	Running time of stage 7	10.0 s	0.0~999.9 s	Set the running time of stage 7 (Unit is chosen by [F1.35] and defaults to second)

Parameter	Name	Factory Default	Predetermined Area	Content
F1.31	Stage acceleration and deceleration time selection 1	0000	0000~1111	Ones place: Acceleration and deceleration time in stage 1, 0~1 Tens place: Acceleration and deceleration time in stage 2, 0~1 Hundreds place: Acceleration and deceleration time in stage 3, 0~1 Thousands place: Acceleration and deceleration time in stage 4, 0~1
F1.32	Stage acceleration and deceleration time option 2	000	000~111	Ones place: Acceleration and deceleration time in stage 5, 0~1 Tens place: Acceleration and deceleration time in stage 6, 0~1 Hundreds place: Acceleration and deceleration time in stage 7, 0~1 Thousands place: Reserve
F1.33	Acceleration time 2	10.0 s	0.1~999.9 s 0.4~4.0 kW 10.0 s 5.5~7.5 Kw 15.0 s	Set acceleration and deceleration time 2
F1.34	Deceleration time2			
F1.35	Time unit selection	000	000~211	Ones place: Time unit of process PLC Tens place: Time unit of simple PLC Hundreds place: Regular acceleration and deceleration time Thousands place: Reserve 0: Unit is in 1 second 1: Unit is in 1 minute 1: Unit is in 0.1 second
F1.36	Forward and reverse operation dead time	0.0	0.0~999.9 s	The transition time at the output zero frequency during the transition from forward operation to reverse operation, or from reverse operation to forward operation

Parameter	Name	Factory Default	Predetermined Area	Content
F2 Group - Analog and digital input and output parameters				
F2.00	AI input lower limit voltage	0.00V	0.00 ~ [F2.01]	Set AVI upper and lower limits of voltage
F2.01	AI input upper limit voltage	10.00V	[F2.01] ~10.00V	
F2.02	AI lower limit corresponding setting	0.0%	-100.0%~ 100.0%	Set the AVI upper and lower limits corresponding setting which is corresponding to the percentage of the upper limit frequency [F0.05]
F2.03	AI upper limit corresponding setting	100.0%		
F2.04	retain	-	-	-
F2.05	retain	-	-	
F2.06	retain	-	-	-
F2.07	retain	-		
F2.08	Time constant of analog input signal filtering	0.1s	0.1~5.0s	This parameter is used to filter input signals of AVI, ACI and panel potentiometers to eliminate the influence of interference

Parameter	Name	Factory Default	Predetermined Area	Content
F2.09	Anti-shake of analog input	0.00V	0.00~0.10 V	When the analog input signal fluctuates frequently near the given value, F2.09 can be set to suppress the frequency fluctuation caused by this fluctuation
F2.10	AO analog output terminal function options	0	0~5	0: Output frequency 1: Output current 2: Motor speed 3: Output voltage 4: AV1 5: AC1
F2.11	AO output lower limit	0.00V	0.00~10.00V	Set the AO output upper and lower limits
F2.12	AO output upper limit	10.00V		
F2.13	Input Terminal X1 function	3	0~30	0: Idle control terminal 1: Forward jog control 2: Reverse jog control 3: Forward control (FWD) 4: Reverse control (REV) 5: Three-wire operation control 6: Free stop control 7: External stop signal input (STOP) 8: External reset signal input (RST)
F2.14	Input Terminal X2 function	4	0~30	9: External fault normally open input 10: Frequency up command (UP) 11: Frequency down command (DOWN) 13: Multi-speed option S1 14: Multi-speed option S2 15: Multi-speed option S3 16: Run command channel forced to be terminal
F2.15	Input Terminal X3 function	13	0~30	17: Run command channel forced to be communication 18: Stop DC braking command

F2.16	Input Terminal X4 function	14	0~30	19: Frequency switching to AI 20: Frequency switching to digital frequency 1 21: Frequency switching to digital frequency 2 22: Retain 23: Counter clear signal 24: Counter trigger signal 25: Timer clear signal 26: Timer trigger signal 27: Acceleration/deceleration time options 28: Swing frequency pause (Stop at current frequency) 29: Swing frequency pause (Stop at center frequency) 30: External stop / reset signal input (stop / RST)
F2.17	Input Terminal X5 function	8	0~30	
F2.18	FWD/REV terminal control mode	0	0~3	0: Two-wire control mode 1 1: Two-wire control mode 2 2: Three-wire control mode 1 3: Three-wire control mode 2
F2.19	Terminal function detection selection at power-on	0	0~1	0: Terminal run command is invalid at power-on 1: Terminal run command is valid at power-on
F2.20	Relay output setting		0~17	0: Idle 1: The frequency converter is ready for operation 2: The frequency converter is running 3: The frequency converter runs at zero speed 4: External downtime 5: Frequency converter failure 6: Frequency/speed arrival signal (FAR) 7: Frequency/speed level detection signal (FDT) 8: Output frequency reaches the upper limit 9: Output frequency reaches the lower limit 10: Frequency converter overload pre-alarm

F2.21	Y open collector output			11: Timer overflow signal 12: Counter detection signal 13: Counter reset signal 14: Auxiliary motor 15: Forward rotation 16: reversal 17: When the output frequency drops to the speed detection level, an indication signal is output
F2.22	R closing delay	0.0s	0.0~255.0s	The delay of the relay R state has change to the output has change
F2.23	R disconnection delay			
F2.24	Frequency reaches the FAR detection range	5.0Hz	0.0Hz~15.0Hz	The output frequency is within the positive and negative detection width of the set frequency, and the terminal outputs a valid signal (low level)
F2.25	FDT level setting value	10.0 Hz	0.0Hz~frequency upper limit	
F2.26	FDT lagged value	1.0Hz	0.0~30.0Hz	
F2.27	UP/DOWN terminal modification rate	1.0Hz/s	0.1Hz~99.9Hz/s	The function code is the frequency modification rate when the UP/DOWN terminal setting frequency is set, that is, the amount of frequency change when UP/DOWN terminal is shorted to the COM terminal for one second.
F2.28	Input terminal pulse trigger mode setting (X1~ X5)	0	0~1	0 : Indicates the level trigger mode 1 : Indicates the pulse trigger mode

Parameter	Name	Factory Default	Predetermined Area	Content
F2.29	Input terminal effective logic setting (X1~X5)	0	0~1	0 : Indicates positive logic, that is, the connection between the Mi terminal and the common terminal is valid, and the disconnection is invalid 1 : Indicates the inverse logic, that is, the connection between the Mi terminal and the common terminal is invalid, and the disconnection is valid
F2.30	X1 Filter coefficient	5	0~9999	Used to set the sensitivity of the input terminals. If the digital input terminal is susceptible to
F2.31	X2 Filter coefficient	5	0~9999	interference and cause malfunction, you can increase this parameter to increase the anti-interference ability,
F2.32	X3 Filter coefficient	5	0~9999	
F2.33	X4 Filter coefficient	5	0~9999	but if the setting is too large, the sensitivity of the input terminal will decrease.
F2.34	X5 Filter coefficient	5	0~9999	1: Represent 2MS scan time unit
F3 Group - PID parameters setting				
F3.00	PID function setting	1010	0000~2122	Ones place: P characteristics 0: Invalid 1: Negative feedback 2: Positive feedback. Tens place: PID given amount input channel 0: Keyboard potentiometer 1: Digital setting The PID given amount is given by the number and set by the function code F3.01. 2: Pressure given (MPa, Kg) The pressure is given by setting F3.01 and F3.18. Hundreds place: PID feedback amount input channel 0: AI 1: Retain

Parameter	Name	Factory Default	Predefined Area	Content
				Thousands place: PID Sleep options 0: Invalid 1: Normal sleep This mode needs to set specific parameters such as F3.10~F3.13. 2: Disturbing sleep The parameter setting is the same as when the sleep mode is selected as 0. If the PID feedback value is within the range of the F3.14 set value, enter the disturbance sleep after the sleep delay time is maintained. When the feedback value is less than the wake threshold (the PID polarity is positive), it will wake up immediately
F3.01	The number setting given amount	0.0%	0.0~100.0%	Use the operation keypad to set the given amount of PID control. This function is valid only when the PID given channel selecting digital is given (F3.00 tens place is 1 or 2). If the F3.00 tens place is 2, it is used as the pressure given, and the unit of this parameter is consistent with of F3.18
F3.02	Gain of feedback channel	1.00	0.01~10.00	This function can be used to adjust the gain of the feedback channel signal when the feedback channel does not match the set channel level.
F3.03	Proportional gain P	2.00	0.01~5.00	The speed of the PID adjustment is set by the two parameters of proportional gain and integration time. It is required to increase the proportional gain and reduce the integration time to get high adjustment speed.
F3.04	Integration time Ti	1.0 s	0.1~50.0s	

Parameter	Name	Factory Default	Predetermined Area	Content
F3.05	Derivative time Td	0.0s	0.1~10.0s	It is required to reduce the proportional gain and increase the integration time to get a low adjustment speed. In general, the derivative time is not set
F3.06	Sampling period T	0.0s	0.1~10.0s	The larger the sampling period, the slower the response, but the better the suppression of the interference signal, and it is generally not necessary to set it.
F3.07	Deviation limit	0.0%	0.0~20.0%	The deviation limit is the ratio of the absolute value of the deviation between the system feedback quantity and the given quantity to the given quantity, when the feedback quantity is within the deviation limit range, the PID adjustment does not work.
F3.08	Closed loop preset frequency	0.0Hz	0.0~upper limit frequency	Frequency and running time of the frequency
F3.09	Preset Frequency hold time	0.0s	0.0~999.9s	converter before the PID is put into operation
F3.10	Wake-up threshold coefficient	100.0%	0.0~150.0%	If the actual feedback value is greater than the set value and the output frequency of the frequency converter reaches the lower limit frequency, the frequency converter enters the sleep state (i.e., zero speed running) after the delay waiting time defined by P3.12; the value is the percentage of PID set value.
F3.11	Awakening threshold coefficient	90.0%	0.0~150.0%	If the actual feedback value is less than the set value, the frequency converter will leave the sleep state after the delay waiting time defined by
				F3.13, and start working; this value is the percentage of the PID set value

Parameter	Name	Factory Default	Predefined Area	Content
F3.12	Sleep delay time	100.0s	0.0~999.9s	Set the sleep delay time
F3.13	Awakening delay time	1.0s	0.0~999.9s	Set the awakening delay time
F3.14	The difference between the feedback and the set pressures when entering sleep	0.5%	0.0~10.0%	This function parameter is valid only for the disturbance sleep mode.
F3.15	Burst detection delay time	30.0S	0.0~999.9s	Set the burst detection delay time, which is invalid when the value is 0
F3.16	High pressure detection threshold	150.0%	0.0~200.0%	When the feedback pressure is greater than or equal to this set value, the tube explosion fault "EPA0" is reported after the P3.15 burst tube delay. When the feedback pressure is less than this set value, the burst alarm "EPA0" is automatically reset; the given threshold is the percentage of pressure.
F3.17	Low pressure detection threshold	50.0%	0.0~200.0%	When the feedback pressure is less than or equal to this set value, the tube explosion fault "EPA0" is reported after the F3.15 burst tube delay. When the feedback pressure is greater than this set value, the burst alarm "EPA0" is automatically reset; the given threshold is the percentage of pressure.
F3.18	Sensor range	10.00M Pa	0.00~99.99 (MPa/Kg)	Set the maximum range of the sensor

Group F4 - Advanced Function Parameters

Parameter	Name	Factory Default	Predetermined Area	Content
F4.00	Motor rated voltage	According to device	0~500V: 380V 0~250V: 220V	Motor parameter setting
F4.01	Motor rated current	According to device	0.1~999A	
F4.02	Motor rated speed	According to device	0~9999rpm	
F4.03	Motor rated frequency	50.0Hz	1.0~999.9Hz	
F4.04	Motor stator resistance	According to device	0.001~20.00Ω	Set the motor stator resistance
F4.05	Motor no-load current	According to device	0.1~ [P4.01]	Set the motor no-load current
F4.06	AVR function	0	0~2	0: Invalid 1: Valid throughout 2: Invalid only during deceleration
F4.07	Cooling fan control	0	0~1	0: Automatic control mode 1: Keep running during the power-on process
F4.08	Number of automatic resets	0	0~10	When the number of fault resets is set to 0, there is no automatic reset function, only manual reset, and 10 means that the number of times is not limited, that is, countless times
F4.09	Interval of fault auto reset	3.0s	0.5~25.0s	Set the interval of fault auto reset
F4.10	Energy consumption brake starting voltage	350/ 780V	330~380/660 ~760V	If the internal DC side voltage of the frequency converter is greater than the energy consumption brake starting voltage, the built-in brake unit operates. If the brake resistor is connected at this time

Parameter	Name	Factory Default	Predefined Area	Content
F4.11	Energy consumption braking action ratio	100%	10~100%	the voltage energy boosted inside the frequency converter will be released through braking resistor, causing the DC voltage to fall back.
F4.12	Energy consumption braking action ratio	0	0~1	0: Invalid 1: Valid
F4.13	PWM mode	2	0~2	0: Full frequency seven stages 1: Full frequency five stages 2: Seven stages to five stages
F4.14	Slip compensation coefficient	100%	0~200%	When the asynchronous motor is loaded, the speed will decrease. The use of slip compensation can make the motor speed close to its synchronous speed, so that the motor speed control accuracy is higher. This coefficient is only valid for normal V/F and simple vector.
F4.15	Slip compensation mode	0	0~1	0: Invalid 1: Low frequency compensation Note: This parameter is only valid for advanced V/F
F4.16	Motor parameter self-learning (reserve temporarily)	0	0~1	0: Invalid 1: Static self-learning (STAR will be displayed immediately after startup, END will be displayed after end and it will be off after 1s
F4.17	Motor rated power	Model setting	0.0 ~ 2000.0KW	After changing the motor rated power f4.17, f4.01, f4.02, f4.04, f4.05, f4.18 ~ f4.20 are automatically updated to the default parameters of the motor with corresponding power.
F4.18	Motor rotor resistance	Model setting	0.00 ~ 200.00Ω	
F4.19	Motor stator and rotor inductance	Model setting	0.00 ~ 200.00mH	
F4.20	Motor stator and rotor mutual inductance	Model setting	0.00 ~ 200.00mH	

Parameter	Name	Factory Default	Predefined Area	Content
F4.21	Speed loop (Asr1) proportional gain	30	1 ~ 100	Function codes f4.21 ~ f4.26 are valid in vector control mode. The speed response characteristics of vector control are changed by setting the proportional gain P and the integration time I.
F4.22	Velocity loop (Asr1) integration time	0.50	0.01 ~ 10.00S	
F4.23	Switching low point frequency	5.0	0.0 ~ 10.0Hz	
F4.24	Speed loop (Asr2) proportional gain	20	1 ~ 100	
F4.25	Velocity loop (Asr2) integration time	1.00	0.01 ~ 10.00S	
F4.26	Switching high point frequency	10.0	【F4.23】 ~ 320.0Hz	
F4.27	Vector slip compensation	100	50% ~ 200%	In the vector control mode, this parameter is used to adjust the speed stability accuracy of the motor. When the motor is overloaded and the speed is low, increase this parameter, otherwise reduce this parameter.
F4.28	Velocity loop filtering time constant	0.010	0.000 ~ 1.000S	Set speed loop filtering time constant
F4.29	Retain	0	-	-
F4.30	Speed loop torque limit	150.0	0.0% ~ 200.0%	This setpoint is a percentage of the rated current of the motor
F4.31	Torque command selection	0	0 ~ 2	0: keyboard number given 1: AI1 2: Reserved
F4.32	Torque digital setting	150.0	0.0% ~ 200.0% *Motor rated current	This setpoint is a percentage of the rated current of the motor

Parameter	Name	Factory Default	Preetermined Area	Content
F4.33	Maximum forward frequency of torque control	50.0	0.0 ~ 3200.0Hz	It is used to set the maximum forward or reverse operating frequency of the frequency converter under torque control mode.
F4.34	Torque control reverse maximum frequency	50.0	0.0 ~ 3200.0Hz	
F4.35	Torque rise time	0.00	0.00 ~ 1.00S	Torque rise / fall time defines the time when the torque rises from 0 to the maximum or decreases from the maximum to 0.
F4.36	Torque drop time	0.00	0.00 ~ 1.00S	
Group F5 - Protection function parameters				
F5.00	Protection settings	0001	0000~1211	Ones place: motor overload protection option 0: Invalid 1: Valid Tens place: PID feedback disconnection protection 0: Invalid 1: Protect action and stop freely Hundreds place: Reserve Thousands place: Oscillation suppression options 0: Invalid 1: Valid
F5.01	Motor overload protection coefficient	100%	30%~110%	The motor overload protection coefficient is the percentage of the motor rated current value to the rated output current of the frequency converter.
F5.02	Undervoltage protection level	180/360V	150-280 300-480V	This function code specifies the lower limit voltage allowed by the DC bus when the frequency converter is working normally
F5.03	Deceleration voltage limiting coefficient	1	0: shut down 1~255	This parameter is used to adjust the ability of the frequency converter to suppress overvoltage during deceleration.

Parameter	Name	Factory Default	Predefined Area	Content
F5.04	Overvoltage limit level	375/790V	350-380 660-760V	The overvoltage limit level defines the operating voltage for overvoltage stall protection
F5.05	Acceleration current limit coefficient	10	0: shut down, 1~99	This parameter is used to adjust the ability of the frequency converter to suppress overcurrent during acceleration.
F5.06	Constant speed current limiting coefficient	0	0: shut down, 1~10	This parameter is used to adjust the ability of the frequency converter to suppress overcurrent during constant speed.
F5.07	Current limit level	180%	50%~250%	The current limit level defines the current threshold for the automatic current limit action, and its set value is relative to the percentage of rated current of the frequency converter.
F5.08	Feedback disconnection detection value	0.0%	0.0~100.0%	The value is the percentage of given amount of the PID. When the feedback value of the PID continues to be less than the feedback disconnection detection value, the frequency converter will make the corresponding protection action according to the setting of P5.00, which is invalid when P5.08=0.0%.
F5.09	Feedback disconnection detection time	10.0s	0.1~999.9S	After the feedback disconnection occurs, the delay time before the action is protected.
F5.10	Frequency converter overload pre-alarm level	120%	0~150%	The current threshold of the frequency converter overload pre-alarm action, the set value is relative to the rated current of the frequency converter.

Parameter	Name	Factory Default	Predetermined Area	Content
F5.12	Jog priority enable	0	0~1	0: Invalid 1: The jog priority is highest when the frequency converter is running
F5.13	Oscillation suppression coefficient	30	0~200	When the motor is oscillating, you should set the thousands place of F5.00 effective, turn on the oscillation suppression function and adjust by setting the oscillation suppression coefficient. Under normal circumstances, the oscillation amplitude is large
F5.14	Amplitude suppression coefficient	5	0~12	
F5.15	Oscillation suppression lower limit frequency	5.0Hz	0.0~ [F5.16]	and increase the oscillation suppression coefficient F5.13, do not set F5.14~F5.16; if you encounter a special occasion, you need to use F5.13~F5.16 together.
F5.16	Oscillation suppression upper limit frequency	45.0Hz	[F5.15] ~ [F0.05]	
F5.17	Wave-by-wave current limit selection	011	000 ~ 111	Ones place: options in acceleration 0: Invalid 1: Valid Tens place: options in deceleration 0: Invalid 1: Valid Hundreds place: Options in constant speed running 0: Invalid 1: Valid Thousands place: Reserve
F5.18	Output phase loss protection detection coefficient	2.00	0.00~20.00	When the ratio of the maximum value to the minimum value of the three-phase output current is greater than this coefficient, and the duration exceeds 6 seconds, the frequency converter reports the output current unbalance fault ETUN

Parameter	Name	Factory Default	Predetermined Area	Content
F5.19	Momentary power down frequency reduction coefficient	0	0: Momentary stop function is invalid 1~100	Set the momentary power down frequency reduction coefficient
F5.20	Momentary power down frequency reduction point	According to device	220V:180 ~ 330V 250V 380V: 300 ~ 550V 450V	Set the momentary power down frequency reduction point
F6 Group- Communication parameters (optional)				
F6.00	Native address	1	0~247	Set the native address, and 0 is the broadcast address.
F6.01	MODBUS communication configuration	0000	0000~0322	LED ones place: Baud rate options 0:9600BPS 1:19200BPS 2:38400BPS LED Tens place: Data format 0: No parity 1: Even parity 2: Odd parity LED Hundreds place: Communication Response 0: Normal response 1: Only respond to the slave address 2: No response 3: Slave does not respond to the free stop command of the host in broadcast mode LED Thousands place: Reserve
F6.02	Communication timeout checkout time	10.0s	0.1 ~ 100.0s	If the native machine does not receive the correct data signal within the interval time defined by this function code, then the native machine thinks that the communication has failed, and the frequency converter will decide whether to protect or maintain the current operation according to the setting of the communication

Parameter	Name	Factory Default	Predefined Area	Content
F6.03	Native response delay	5ms	0~200ms	This function code defines the intermediate interval time between the end of the data frame reception of the frequency converter and the transmission of the response data frame to the host computer. If the response time is less than the system processing time, the system processing time shall prevail.
F6.04	Proportional linkage coefficient	1.00	0.01~10.00	This function code is used to set the weight coefficient of the frequency command of the frequency converter received through the RS485 interface as the slave. The actual running frequency of the native machine is equal to the value of this function code multiplied by the frequency setting command value received through the RS485 interface.
F6.04	Proportional linkage coefficient	1.00	0.01~10.00	In the linkage control, this function code can set the ratio of the running frequency of multiple frequency converters.
F6.05	Multi-manufacturer agreement selection (reserve)	0	0~3	0: DELTA-M series 1: MD380 series 2: ZC series 3: CHF series Try to be compatible with multi-manufacturer communication protocols depending on the memory capacity
Group F7 - Supplementary function parameters				
F7.00	Counting and timing mode	103	000~303	Ones place: Counting arrival processing 0: Single cycle count, stop outputting 1: Single cycle count, continue to output 2: Loop count, stop outputting

Parameter	Name	Factory Default	Predetermined Area	Content
F7.00	Counting and timing mode	103	000~303	3: loop count, continue to output Tens place: Reserve Hundreds place: Timing Arrival processing 0: One-week timing, stop outputting 1: Single-cycle timing, continue to output 2: Cycle timing, stop outputting 3: Cycle timing, continue to output Thousands place: Reserve
F7.01	Counter reset value setting	1	[F7.02]~9999	Set the counter reset value
F7.02	Counter detection value setting	1	0~ [F7.01]	Set the counter detection value
F7.03	Timed time setting	0s	0 ~ 9999s	Set timed time
F7.04 ~ F7.07	Retain	0	-	-
F7.08	Swing frequency control	0	0~1	0 : Forbidden 1 : Valid
F7.09	Swing control	0	0~1	0: Fixed swing The swing reference value is the maximum output frequency (F0.04). 1: Variable swing The swing reference value is the given channel frequency.
F7.10	Swing frequency stop start mode selection	0	0~1	0: Start according to the state memorized before stopping 1: Restart
F7.11	Swing frequency amplitude	0.0%	0.0~100.0%	The swing frequency amplitude is the percentage relative to the maximum output frequency (F0.04).

Parameter	Name	Factory Default	Predefined Area	Content
F7.12	Kick frequency	0.0%	0.0~50.0%	This function code refers to the amplitude of the rapid decrease after the frequency reaches the upper limit frequency of the swing frequency during the swing frequency process. Of course, it also refers to the amplitude of the rapid increase after the frequency reaches the lower limit frequency of the swing frequency. This value is the percentage relative to the swing frequency amplitude (F7.07). If it is set to 0.0%, there is no sudden jump frequency.
F7.13	Swing frequency rising time	5.0	0.1~3600.0s	The running time from the lower limit frequency to the upper limit frequency of the swing frequency.
F7.14	Swing frequency falling time	5.0	0.1~3600.0s	The running time from the upper limit frequency to the lower limit frequency of the swing frequency.
F7.15	Swing frequency upper limit frequency delay	5.0	0.1~3600.0s	Set the swing frequency lower and upper limit frequency delay
F7.16	Swing frequency lower limit frequency delay	5.0	0.1~3600.0s	
Group F8 - Management and display parameters				
F8.00	Operation monitoring parameter item selection	0	0~28	The default display items of the main monitoring interface. The corresponding number is the parameters of d group
F8.01	Shut-down monitoring parameter selection	1	0~28	The default display items of the main monitoring interface. The corresponding number is the parameters of d group

Parameter	Name	Factory Default	Predetermined Area	Content
F8.02	Running auxiliary display (only valid for dual display)	4	0~28	The default display items of the main monitoring interface. The corresponding number is the parameters of d group
F8.03	Shut-down auxiliary display (only valid for dual display)	3	0~28	The default display items of the main monitoring interface. The corresponding number is the parameters of d group
F8.04	Motor speed display factor	1.00	0.01~99.99	It is used to correct the display error of the speed scale and has no effect on the actual speed.
F8.05	Parameter initialization	0	0~2	0: No operation 1: Restore factory settings All user parameters are restored to the factory settings according to device. 2: Clear the fault record Clear the contents of the fault record (d-19~d-24).
F8.05	Parameter initialization	0	0~2	This function code is automatically cleared to 0 after the operation is completed.
P8.06	JOG key setting	0	0~3	0: JOG 1: Forward and reverse switching 2: Clear frequency setting of ▲/▼ button 3: Reverse run (At this time, the RUN button defaults to forward)
Group F9 - manufacturer parameters				
F9.00	Manufacturer password		1~9999	System setting special password
F9.01	Device selection	1	0-14	220V: 0: 0.4KW 1: 0.75KW 2: 1.5KW 3: 2.2KW 4: 4.0KW 5: 5.5KW 6: 7.5KW 380V: 7: 0.4KW 8: 0.75KW 9: 1.5KW 10: 2.2KW 11: 3.0KW 12: 4.0KW 13: 5.5KW 14: 7.5KW

Parameter	Name	Factory Default	Predetermined Area	Content
F9.02	Dead time	According to device	2.5~4.0 μ S	2.5 ~ 4.0 μ S 0.4 ~ 4.0KW 2.8 μ S 5.5KW ~ 22KW 3.2 μ S
F9.03	Software overvoltage detection value	400/810 V	0~450V/900V	Overvoltage detection threshold
F9.04	Voltage correction coefficient	1.00	0.80~1.20	Bus voltage value used for calibration test
F9.05	Current correction coefficient	1.00	0.80~1.20	Current value used for calibration test
F9.06~F9.09	Reserve	0		Reserve
F9.10	Special function selection	According to device	0-2	Ones place: selection of accumulated running time clear 0: Invalid, 1: Valid Tens place: model selection 0: General model (G), 1: Light load model (F), 2: Heavy load model (Z) Hundreds place: reserve Thousands place: reserve Note: F9.01 is set to 0~6 and 12~14, the tens place factory default of F9.10 is 0; F9.01 is set to 15, the tens place factory default of F9.10 is set to 1; F9.01 is set to 7~11, the tens place factory default of F9.10 is set to 2.

Group d - Monitoring parameter group

Parameter	Name	Range	Minimum unit
d-00	Output frequency (Hz)	0.0~999.9Hz	0.1Hz
d-01	Set frequency (Hz)	0.0~999.9Hz	0.1Hz
d-02	Output voltage (V)	0~999V	1V
d-03	Bus voltage (V)	0~999V	1V

Parameter	Name	Range	Minimum unit
d-04	Output current (A)	0.0~999.9A	0.1A
d-05	Motor speed (Krpm)	0~60000Krpm	1Krpm
d-06	Analog input AI(V/ mA)	0.00~10.00V/0.00 ~20.00mA	0.01V/0.01mA
d-07	Retain	0	0
d-08	Analog output AO(V)	0.00~10.00V	0.01V
d-09	Reservation	-	-
d-10	Retain	-	-
d-11	PID pressure feedback value	0.00~10.00V/0.00 ~ 99.99(MPa/Kg)	0.01V/(MPa /Kg)
d-12	Current count value	0~9999s	1s
d-13	Current timing value (s)	0~9999s	1s
d-14	Input terminal status (X1-X5)	0~1FH	1H
d-15	Output relay status (R)	0~3H	1H
d-16	Module temperature (°C)	0.0~132.3°C	0.1°C
d-17	Software upgrade date (year)	2010~2026	2021
d-18	Software upgrade date (month, day)	0~1231	0615
d-19	Second fault code	0~19	1
d-20	Last fault code	0~19	1
d-21	Output frequency (Hz) in the most recent fault	0.0~999.9Hz	0.1Hz
d-22	Output current (A) in the most recent fault	0.0~999.9A	0.1A
d-23	Bus voltage (V) in the most recent fault	0~999V	1V

Parameter	Name	Range	Minimum unit
d-24	Module temperature in the most recent fault (°C)	0.0~132.3°C	0.1°C
d-25	Accumulated running time of the frequency converter (h)	0~9999h	1h
d-26	Frequency converter status	0 ~ FFFFH BIT0: Run/Stop BIT1: Reverse / Forward BIT2: Jog BIT3: DC braking BIT4: Reserve BIT5: Overvoltage limit BIT6: Frequency decreasing in constant speed BIT7: Overcurrent limit BIT8~9:00-zero speed/01-acceleration/10-deceleration/11-constant speed BIT10: Overload pre-alarm BIT11: Reserve BIT12~13 running command channel: 00-panel/01-terminal /10-reserve BIT14~15 bus voltage status: 00-normal/01-low voltage protection/10-overpressure protection	1H
d-27	Software version	1.00~99.99	0.01
d-28	Power model	0.10~99.99 kW	0.01 kW
Group E - Fault code			

Fault code	Name	Possible reason of failure	Troubleshooting
EOC1	Overcurrent during acceleration	Acceleration time is too short	Increase the acceleration time
		The power of frequency converter is small	Use a frequency converter with a large power level
		Improper setting of V/F curve or torque boost	Adjust the V/F curve or torque boost
EOC2	Overcurrent during deceleration	Acceleration time is too short	Increase the acceleration time
		The power of frequency converter is small	Use a frequency converter with a large power level
EOC3	Overcurrent during constant speed operation	Low grid voltage	Check input power
		Load become mutational or abnormal	Check load or reduce load change
		The power of frequency converter is small	Use a frequency converter with a large power level
EHU 1	Overvoltage during acceleration	Abnormal input voltage	Check input power supply
		Restart the rotating motor	Set to start after DC braking
EHU 2	Overvoltage during deceleration	Deceleration time is too short	Increase deceleration time
		Abnormal input voltage	Check input power supply

Fault code	Name	Possible reason of failure	Troubleshooting
EHU 3	Overvoltage during constant speed operation	Abnormal input voltage	Check input power supply
EHU 4	Overvoltage during shut-down	Abnormal input voltage	Check the power voltage
ELU0	Undervoltage in operation	The input voltage is abnormal or the relay is not connected	Check the supply voltage or ask the manufacturer for service
ESC1	Power module failure	Frequency converter output short circuiting or grounding	Check motor wiring
		Frequency converter transient overcurrent	Refer to the overcurrent countermeasures
		The control board is abnormal or the interference is serious.	Ask the manufacturer for service
		Power device damage	Ask the manufacturer for service
E-OH	Heat sink overheating	Ambient temperature is too high	Reduce ambient temperature
		Fan damage	Replace the fan
		Air duct blockage	Dredge the air duct

Fault code	Name	Possible reason of failure	Troubleshooting
EOL1	Frequency converter overload	Improper setting of V/F curve or torque boost	Adjust the V/F curve or torque boost
		Grid voltage is too low	Check the grid voltage
		Acceleration time is too short	Increase acceleration time
		Motor overload	Use a frequency converter with a large power level
EOL2	Motor overload	Improper setting of V/F curve or torque boost	Adjust the V/F curve or torque boost
		Grid voltage is too low	Check grid voltage
		Motor stalled or the mutation of load is too large	Check the load
		Motor overload protection factor setting is incorrect	Set the motor overload protection coefficient Correctly
E-EF	External device failure	External device fault input terminal is closed	Disconnect the external device fault input terminal and clear the fault (Pay attention to checking the cause)
EPID	PID Feedback disconnection	PID feedback circuit is loose	Check feedback connection
		The feedback amount is less than the disconnection detection value	Adjust the detection input threshold
E485	RS485 communication failure	Does not match the host computer baud rate	Adjust baud rate

		RS485 channel interference	Check whether the communication connection is shielded, whether the wiring is reasonable, and considering connecting the filter capacitor if necessary.
		Communication timeout	Retry
ECCF	Current detection fault	Current sampling circuit fault	Ask the manufacturer for service
		Auxiliary power fault	
EEEP	EEPROM read-write	EEPROM fault	Ask the manufacturer for service
EPAO	Burst failure	The feedback pressure is less than the low-pressure detection threshold or greater than or equal to the high-pressure detection threshold	Detect feedback connection or adjust detection high- and low-pressure threshold
EPOF	Dual CPU communication failure	CPU communication failure	Ask the manufacturer for service
EPLI	Output phase-loss protection	Output U or V or W has phase loss	Check output wiring
ETUN	Motor tuning failure	Motor parameters are incorrectly set	Reset motor parameters
E-LT	Photovoltaic water pump water failure		

6.Applications

(1) constant pressure water supply control by frequency converter

A: Electric contact pressure gauge control (the simplest control method)

Use the electric contact pressure gauge to control the water pressure. You only need to connect 2 wires, one from the green needle and the other from the black needle, respectively connected to the upper 2 of the 3 terminals of the electric contact pressure gauge (some electric contact table may be different). When the water pressure is low, the black needle is underneath the green needle, and the frequency converter is in the acceleration start state. When the water pressure is high, the black needle is on the top of green needle, and the frequency converter is at the deceleration stop state. Very simple and easy to maintain.

For this frequency converter, the debugging steps are as follows:

① Connect the two wires from the electric contact pressure gauge, one wire of the start signal to X1, and the other wire to GND (no need to distinguish between positive and negative, please connect the start signal after setting all parameters).

② Set parameter F0.02=1 to select external terminal to start control.

③ Turn up the speed control knob on the panel to the maximum.

④ frequency converter parameter setting: F2.13=3 (default value), F0.10=60, F0.11=60, F2.19=1

It can start automatically after power on. If it does not start, you can use a wire to directly connect X1 and GND to see if it starts. If it still fails, it means there is a problem with the internal settings of the frequency converter. If it can be started, it means the external electric contact meter or circuit problem. You can check whether the two wires on the electric contact are connected. If the black needle is lower than the green needle, it should be connected, and if the black needle is higher than the green needle, it should be disconnected.

B: PID constant pressure water supply control (AVI given)

Use the built-in PID control function of the frequency converter for PID adjustment and control, and use pressure sensors or remote pressure gauges for water pressure collection. Debugging steps:

① Connect the water pressure signal of the remote pressure gauge to GND, AVI, and 10V. If it is a 2-wire pressure sensor connected to GND and AVI. The voltage feedback value of the remote pressure gauge can be seen in parameter d-06.

②Parameter setting:

If using the panel to start, set the parameter F0.02=0.

If using external terminals to start, set the parameters F0.02=1, F2.13=3 (default value), F2.19=1 and connect the start signal wire to X1 and GND (after modifying all parameters, connect the start wire).

F0.10=30, F0.11=30 acceleration and deceleration time, which can be adjusted according to actual application

F3.00=1011, PID negative feedback, feedback signal AVI given and PID given amount is given by F3.01.

F3.01, used to set the size of the water pressure, the setting range is 0-100%, through this parameter to adjust the level of the water pressure (0-10V corresponds to the pressure gauge range). It can be adjusted to 20 first, and then adjust the size according to the actual application.

③ Speed of PID control adjustment:

F3.03=1.00 (default value), P value parameter adjustment, the larger the P value, the faster the adjustment speed.

F3.04=2.0 (default value), I value parameter adjustment, the larger the I value, the slower the adjustment speed.

(2) Two speed setting mode control

Equipment requirements: use the potentiometer knob to adjust the speed during forward rotation, and use multi-speed low-speed operation during reverse rotation.

①Parameter setting: F0.02=1, F0.03=3, F1.17=10 (reverse running speed 10HZ)

②Connection: 3 wires of the potentiometer are connected to GND, AVI, +10V, the forward rotation signal is connected to X1 and GND, the reverse signal is connected to X2, GND, and X2 and X3 are short-circuited (set the frequency at the same time when reverse Select the setting value of multi-speed 1).

(3) Jog control

Equipment that needs jog control:

① Parameter setting: F0.02=1, F2.15=1 (forward jog), F2.16=2 (reverse jog), forward jog frequency is given by parameter F1.09, reverse point The dynamic frequency is given by parameter F1.10. The jog acceleration time is set by parameter F1.11, and the jog deceleration time is set by parameter F1.12.

② Wiring: the forward jog signal is connected to GND and X3, and the reverse

jog signal is connected to GND and X4.

(4) Torque is insufficient when running at low speed (rotation is weak)

Adjust parameter F0.14, gradually adjust from small to large. Don't adjust it too large at the beginning. If it is adjusted too large, it may report OC overcurrent fault.

Adjust parameter F0.15, which is the cutoff frequency of torque boost.

(5) Application on engraving machine using Weihong card

When using Weihong card engraving machine,

① Wiring: There will be 4 lines on Weihong card, namely: public line, low-speed line, medium-speed line, and high-speed line. These 4 wires are respectively connected to GND, X3, X4, X5 of the frequency converter

② Parameter setting: F0.02=1, F0.04=400 (set according to the motor nameplate), F0.05=400 (set according to the motor nameplate), F1.17=100, F1.18=150, F1.19= 200, F1.20=250, F1.21=300, F1.22=350, F1.23=400, F2.17=15, F2.19=1.

F4.03=400 (rated frequency of the motor, set according to the nameplate of the motor).

③ After setting the parameters, connect the terminals GND and X1 with wires after power off. Then power on (note: the spindle may rotate after power on, and power on under safe conditions).

Appendix I

Communication protocol

(All of the following data are hexadecimal)

1. RTU mode and format

When the controller is communicating on the Modbus bus in RTU mode, each 8-bit byte in the message is divided into two 4-digit hexadecimal characters. The main advantage of this mode is the density of the transmitted characters at the same baud rate is larger than ASCII mode, and each message must be transmitted continuously.

(1) Format of each byte in RTU mode

Coding system: 8-bit binary, hex 0-9, A-F.

Data bits: 1 start bit, 8 data bits (low bit first), stop bit occupies 1 bit, parity check bit can be selected. (Refer to RTU data frame bit sequence diagram)

Error check area: Cyclic Redundancy Check (CRC)

(2) RTU data frame bit sequence diagram

With parity check

Start	1	2	3	4	5	6	7	8	Par	Stop
-------	---	---	---	---	---	---	---	---	-----	------

Without parity check

Start	1	2	3	4	5	6	7	8	Stop
-------	---	---	---	---	---	---	---	---	------

2. Read-write function code description :

Function code	Function Description
03	Read the register
06	Write the register

3. Parameter description of the communication protocol :

Function Description	Address definition	Data meaning description	R/W
Communication control command	2000H	0001H : Shut down	W
		0012H : Forward running	
		0013H : Forward jog running	
		0022H : Reverse running	
		0023H : Reverse jog running	

Communication setting frequency address	2001H	The communication setting frequency range is -10000 to 10000. Note: The communication setting frequency is the percentage relative to the maximum frequency, which ranges from -100.00% to 100.00%)	W
Communication control command	2002H	0001H : External fault input	W
		0002H : Fault reset	
Read run/stop parameter description	2102H	Setting frequency (two decimal places)	R
	2103H	Output frequency (two decimal places)	R
	2104H	Output current (one decimal place)	R
	2105H	Bus voltage (one decimal place)	R
	2106H	Output voltage (one decimal place)	R
	2107H	Analog input AVI (two decimal places)	R
	2108H	Analog input ACI (two decimal places)	R
	2109H	Current count value	R
	210AH	Motor speed	R
	210BH	Analog input AO (two decimal places)	R
	210CH	Reserve	R
	210DH	Reserve	R
	210EH	PID feedback value (two decimal places)	R
	210FH	PID set value (two decimal places)	R
	2110H	Reserve	R
2111H	Reserve	R	

	2112H	The current fault	R
	2113H	Current timing value	R
	2114H	Input terminal status	R
	2115H	Output terminal status	R
	2116H	Bit0 : Run/stop Bit1 : Forward/reverse Bit2 : Jog Bit3 : DC backing Bit4 : Reverse Bit5: Overvoltage limit Bit6: Frequency reduction with constant speed Bit7: Overcurrent limit Bit8~9: 00-zero speed/01- acceleration/10- deceleration/11- constant speed Bit10: Overload warning Bit11: Reserve Bit12~13: Run command channel:00 panel/01-terminal/10- communication Bit14~15: Bus voltage status:00-normal/01- undervoltage protection/10- overvoltage protection	R
			R
	2101H	Bit0 : Run Bit1 : Stop Bit2 : Jog Bit3 : Forward Bit4 : Reverse Bit5 ~ Bit7: Reserve Bit8: Communication given Bit9: Analog signal input Bit10: Communication running command channel Bit11: Parameter lock Bit12: Running Bit13: Command of having jog Bit14~Bit15: Reserve	R

Read the fault code description	2100H	00: No abnormality 01: Module failure 02: Overvoltage 03: Temperature failure 04: Frequency converter overload 05: Motor overload 06: External fault 07~09: Reserve 10: Overcurrent in acceleration 11: Overcurrent in deceleration 12: Overcurrent in constant speed 13: Reserve 14: Undervoltage	R
---------------------------------	-------	--	---

4.03 read function mode :

Inquiry information frame format:

Address	01H
Function	03H
Starting data address	21H
	02H
Data(2Byte)	00H
	02H
CRC CHK Low	6FH
CRC CHK High	F7H

Analysis of This paragraph of data :

- 01H is the address of frequency converter
- 03H is the read function code
- 2102H is the initial address
- 0002H is the number of read address, that is, 2102and 2103H
- F76FH is the 16-bit CRC checking code

Response information frame format:

Address	01H
Function	03H
DataNum*2	04H

Data1[2Byte]	17H
	70H
Data2[2Byte]	00H
	00H
CRC CHK Low	FEH
CRC CHK High	5CH

Analysis of this paragraph of data:

- 01H is the address of frequency converter
- 03H is the read function code
- 04H is the product of the read item *2
- 1770H is the data of read 2102H (set frequency)
- 0000H is the data of read 2103H (output frequency)
- 5CFEH is a 16-bit CRC checking code

5. 06H read function mode

Inquiry information frame format

Address	01H
Function	06H
Starting data address	20H
	00H
Data(2Byte)	00H
	01H
CRC CHK Low	43H
CRC CHK High	CAH

Analysis of this paragraph of data:

- 01H is the address of frequency converter
- 06H is the write function code
- 2000H is the address of control command
- 0001H is the stop command
- 43CAH is a 16-bit CRC checking code

Response information frame format:

Address	01H
Function	06H
Starting	20H

data address	00H
Number of Data (Byte)	00H
	01H
CRC CHK	43H
CRC CHK	CAH

Analysis of this paragraph of data: If the settings are correct, return the same input data.

Service delivers value, quality creates glory

To customers:

Thank you for using our products. In order to ensure that you get the best after-sales service from our company, please read the following terms carefully and do the relevant matters.

1. Product warranty scope

Any failures that occur under normal use according to the requirements of use are covered by the warranty.

2. Product warranty period

The warranty period of this product is within twelve months from the date of delivery. Long-term technical support services will be implemented after the warranty period.

3. Non-warranty coverage

Any damage caused by human factors, natural disasters, water ingress, external force damage, harsh environment, etc. that violate the requirements of use, as well as unauthorized disassembling, modification and maintenance of the frequency converter, which will be deemed to automatically waive the warranty service.

4. Purchase products from middlemen

Anyone who purchases products from distributors or agents should contact the distributor or agent if the product fails.

Please keep this manual properly in case you need it.