

Directory

Directory	1
1. Safety Information	3
1.1 Safety Precautions	3
1.2 Installation and Wiring	3
1.3 Operation Environment.....	4
2. Standard Specifications of Products.....	4
2.1 Technical Specifications	5
2.2 Chassis and Keyboard Dimensions	7
2.3 Rated Current Output Table	8
2.4 Selection of Braking Resistor.....	9
3. Basic Running Wiring.....	11
3.1 Basic Wiring Diagram	11
3.2 Terminal of Main Loop.....	11
3.3 Terminal of Control Loop	12
3.4 Dial Switch	14
3.5 Wiring Notices	14
4. Operation and Display	15
4.1 Instructions for operation panel.....	15
4.1.1 Operating Panel	15
4.1.2 Operating Panel Keys	15
4.1.3 LED and Indicator Light Description.....	15
4.2 Working Status of the Operating Panel	16
4.2.1 Power-on Working Status	16
4.2.2 Inverter Status Parameter Query	16
4.2.3 Fault Alarm State.....	18
4.3 Operating Panel Operation Method.....	18
4.3.1 Set the Parameters	18
4.4 Automatic Tuning of Motor Parameters	19
4.5 Vector Control Mode Parameter Settings	19
5. Standard Parameter Table	21
6. Detailed Explanation of Parameters.....	55
P0 Group - Basic Run Parameters	55
P1 Group - Motor 1 Parameters	59
P2 Group - Vector Control Parameters of Motor 1	61

P3 Group - V/F Control parameters	64
P4 Group - Digital Input Parameters	67
P5 Group - Digital Output Parameters.....	75
P6 Group - Start/Stop Control Parameters.....	79
P7 Group - Parameters of Panel Function Setting and Parameter Management.....	82
P8 Group - Auxiliary Function Parameters.....	83
P9 Group - Parameters of Fault and Protection.....	89
PA Group - PID Control Parameters	97
Pb Group - Parameters of Wobble Function, Fixed Length and Count.....	101
PC Group - Parameters of Multi-Reference and Simple PLC Function.....	103
Pd Group - Communication Parameters	104
PP Group - User Password Parameters	105
d0 Group - Parameters of Torque Control and Limit	106
d2 Group - Motor 2 Parameters.....	107
d5 Group - Control Optimization Parameters	108
d6 Group - Parameters of AI Curve Setting.....	109
d9 Group - Control Optimization Parameters	110
dC Group - AI/AO Correction Parameters	111
U0 Group - Monitoring Parameters.....	112
7. Troubleshooting.....	113
7.1 Fault Information and Troubleshooting	113
Appendix :.....	119
A. Modbus Communication Protocol.....	119
B. LCD Panel Operation Instructions.....	125
C. Warranty Agreement	127

1. Safety Information

1.1 Safety Precautions

- Do not install this equipment in an explosive gas atmosphere, or there will be explosion hazards.
- Only qualified individuals should proceed with wiring, or there will be electric shock hazards.
- Do not conduct any wiring during the system power on to avoid the electric shock.
- Do not touch control terminals, internal circuit board and its components, or there will be electric shock hazard.
- Earth terminal must be exactly grounded when using inverter. Grounding must be confirmed with the national electric safety regulation and other electric code.
- After power off, do not touch internal circuit board or any parts inside within 5 minutes after keypad display went off. Any internal operation must be after making sure of discharge off with instrument checking to avoid the electric shock.
- Do not connect AC power to output terminal (U, V, W) of inverter. The only terminal the AC power allowed to be connected is R, S, T (or R, T single-phrase source inverter).
- Static electricity on human body can damage MOS device. Do not touch PCB and IGBT without anti-static measure.
- Do not lose screws, spacers and other metallic foreign bodies inside the driver to avoid fire hazard and driver damage.
- Do not connect 220V AC power to internal control terminal of the driver, or there will be serious damage to the driver.
- If overcurrent protection occurs after start the driver, confirm again the external wiring and then power on and run the driver.
- Do not switch off the power to stop the driver. Cut off power source after the motor stops running.
- Do not install the driver in places with direct sunlight.

1.2 Installation and Wiring

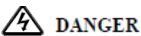

- Ensure the power has been cut off before wiring, Electric chock and fire hazard.
- Ask electric engineering professionals to conduct wiring.
- Earth terminals must be reliable grounded.
- (380V class: especially the third grounding) Electric shock and fire hazard.
- Check if its action is effective after emergency brake terminal is connected.
- Injury risk (wiring responsibility should be beard by users).
- Do not touch output terminals directly. The output terminal is connected directly to motor. There should be no short circuit between output terminals.
- Install the terminal cover before power on, and ensure power off when dismantling the terminal cover Electric.

- Conduct check and maintenance after 5 to 8 minutes after power off when internal residual electricity is discharged completely.
- Hazard of residual voltage in electrolytic capacitor.

**CAUTION**

- Check if the voltage of power inlet wire agrees with rated input voltage of VFD.
- Connect brake resistor or brake unit according to wiring diagram.
- Choose screw driver and wrench with specified torque to fasten terminals.
- Do not connect the power input wire to output U, V, W terminals.
- It will cause internal damage to VFD if load the voltage on output terminals.
- Do not dismantle the front panel cover, only the terminal cover needs to be dismantled when wiring.

1.3 Operation Environment

- No corrosive gases, vapors, dust or oily dust, no direct sunlight.
- No floating dust and metal particle.
- Ambient humidity 20% to 90% RH.
- Vibration less than $5.9\text{m/s}^2(0.6\text{g})$.
- No electromagnetic interference.
- Ambient temperature -10°C to 40°C . Ensure good ventilation when ambient temperature exceeds 40°C .
- Use electric cabinet or remote control method in non-standard operation environment and ensure good ventilation and heat dissipation. The service life of VFD lies in installing environment and operation condition. But even in standard environment, a long-term continuous running can guarantee a life of no more than 5 years for electrolytic capacitor and about 3 years for cooling fan. An update or a thorough maintenance in advance is recommended.

2. Standard Specifications of Products

2.1 Technical Specifications

Item		Description		
Output	Output voltage	0V to the input voltage		
	Output frequency	Low - frequency mode : 0.00Hz to 500.00Hz High - frequency mode : 0.0Hz to 3200.0Hz		
	Carrier frequency	0.8kHz to 16.0kHz (automatic adjustment according to the load)		
	Overload capacity	150% / 1 min		
Input	Voltage/Frequency	3-phase: 380V; 50/60Hz 1-phase: 220V; 50/60Hz		
	the fluctuation of voltage	3-phase: 380V AC $\pm 15\%$, allowable range: 323V AC to 437V AC 1-phase: 220V AC $\pm 15\%$, allowable range: 187V AC to 253V AC		
	Frequency range	G type: 110% for long-term, 120% for 22 min, 150% for 1min P type: 105% for long-term, 120% for 8 min, 150% for 1min		
Control Character	Frequency Setting Resolution	Analog Input	0.025% of maximum output frequency	
		Digital Setting	0.01 Hz	
	Control mode	Voltage/Frequency (V/F) control, Sensorless vector control (SVC) and Feedback vector control (FVC)		
	Startup torque	SVC	0.25 Hz/150%	
		FVC	0 Hz/180%	
	Speed range	SVC	1: 200	
		FVC	1: 1000	
	Speed stability accuracy	SVC	$\pm 0.5\%$ (SVC)	
		FVC	$\pm 0.02\%$ (FVC)	
	Torque boost	Customized boost 0.0 % to 30.0 %		
	V/F curve	Straight-line V/F curve, Multi-point V/F curve, Complete V/F separation and Half V/F separation		
	Wave current limit	In V/F mode, to achieve fast response and ensure the normal operation of the inverter		
	Ramp mode	Straight-line ramp, S-curve ramp Four separate acceleration/deceleration time: 0.1s to 6500s		
	Automatic voltage regulation (AVR)	The system maintains a constant output voltage automatically when the grid voltage changes through the permissible range.		
	DC injection braking	DC injection braking frequency: 0 Hz to max frequency DC injection braking active time: 0.0s to 100.0s Current level of DC injection braking: 0% to 100%		
	Jog running	Frequency range of jog running: 0.00 to max frequency Acceleration/Deceleration time of jog running: 0.0s to 6500.0s		
	Onboard multiple preset speeds	The system implements up to 16 speeds by using simple PLC function or by using digital input signals.		
Overvoltage and overcurrent stall control	Overvoltage and overcurrent stall control			
Torque limit and control	The system limits the torque automatically. Torque control is applied in vector control.			

(continued)	Undervoltage Restrain during Running	Specially for users with a low or unsteady voltage power grid: even lower than the allowable voltage range, the system can maintain the longest possible operating time based on its unique algorithm and residual energy allocation strategy	
Control input and output signals	Command source	Allows different methods of switching between command sources: Operating panel (keypad & display), Terminal I/O control and Serial communication	
	Main frequency reference setting channel	Allows different methods of switching between frequency reference setting channels: Digital setting, Analog voltage reference, Analog current reference, Pulse reference(Optional), Communication reference	
	Auxiliary frequency reference setting channel	Allows fine tuning of the auxiliary frequency and main & auxiliary calculation.	
	Input terminals	0 to 5V keyboard potentiometer input Six digital input (X) terminals, one of which supports up to 50 kHz high-speed pulse inputs(Optional). Two analog input (AI) terminals, one of which supports only 0 to 10V input, and the other supports 0 to 10 V and 4 to 20 mA current input.	
	Output terminals	Single open-collector output terminal (high-speed pulse (Optional)) for a square-wave signal Single relay output terminal Single extra AO terminal	
	serial communication interface	RS-485 interface	
Protective Function		Overcurrent, overvoltage, undervoltage, module fault, electric thermal relay, overheat, short circuit, default phase of input and output, motor parameter adjustment abnormality, internal memory fault, etc.	
Display	Five digit digital display (LED) and Status indicator light	Parameter setting: Display parameter number and value.	Function code, Data, status
		Running state display: Display operation frequency, current, etc.	
		Fault display: Display the fault code.	
Environment	Installation location	Install the inverter where it is indoors and protected from direct sunlight, dust and corrosive or combustible gases. Running in derated capacity above 1000m.	
	Ambient Temperature	-10°C to +40°C (please run the VFD in derated capacity when ambient temperature is 40°C to 50°C)	
	Ambient Humidity	20% to 95%RH, without condensing drops	
	Operation temperature	-10°C to +50°C	
	Vibration	Less than 0.5 g	
	Storage	-25°C to +65°C	
	Installation Method	Wall-hanging type, cabinet type	
Structure	Protection Level	IP20	
	Cooling Method	Air cooling with fan control	

2.2 Chassis and Keyboard Dimensions

Chassis size:

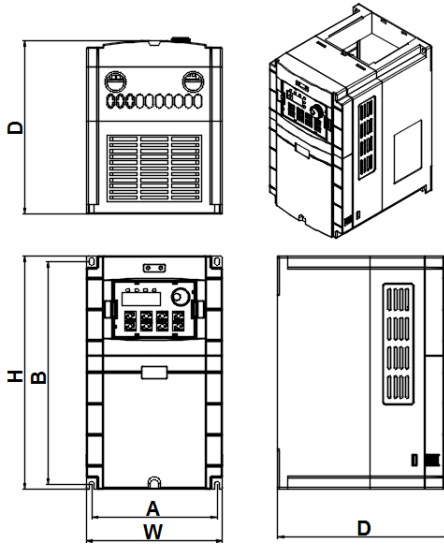

Figure 2-1 Inverter 0.75kW to 315kW external dimensions

Machine type	A (mm)	B (mm)	H (mm)	W (mm)	D (mm)	Mounting hole (mm)
	Installation size		Peripheral dimension			
0.75kW-2.2kW G3/S1/S3	99	154	166	109	146	4.5
4.0kW-5.5kW G3	119	201	215	131	174	5.5
4.0kW-5.5kW S1/S3 7.5kW-11kW G3	130	237	249	143	181	5.5
7.5kW-11kW S3 15kW-22kW G3	188	305	324	209	192	6.5
15kW-22kW S3 30kW-37kW G3	264	388	408	288	209	7
30kW S3 45kW-55kW G3	235	485	510	320	248	8.5
37kW-55kW S3 75kW-110kW G3	240	635.5	655	377	267	8.5
132kW-185kW G3	320	730	750	495	325	13
200kW-280kW G3	460	980	1005	632	440	13/16
315kW-500kW G3	600	1210	1250	800	450	13/16

Keyboard installation dimensions:

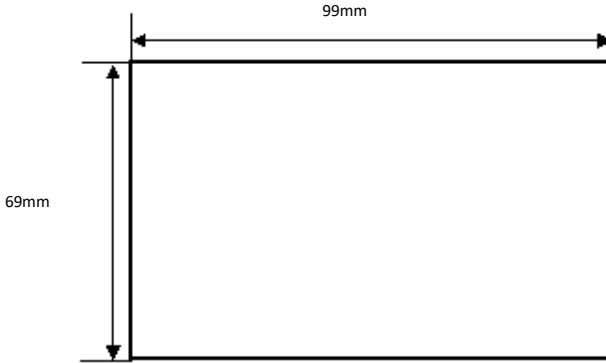

Figure 2-2 External panel installation dimensions (open - hole dimensions)

2.3 Rated Current Output Table

Voltage	single - phase	three - phase	
	220V	220V	380V
Power(kW)	current (A)	current (A)	current (A)
0.75	4	4	2.1
1.5	7	7	3.8
2.2	9.6	9.6	5.1
4.0	17	17	9
5.5	25	25	13
7.5	-	32	17
11	-	45	25
15	-	60	32
18.5	-	75	37
22	-	80	45
30	-	110	60
37	-	152	75
45	-	176	90
55	-	210	110
75	-	-	152
93	-	-	176
110	-	-	210
132	-	-	253
160	-	-	304
185	-	-	340
200	-	-	380
220	-	-	426
250	-	-	465
280	-	-	520
315	-	-	585
355	-	-	650
400	-	-	725
450	-	-	820
500	-	-	900

2.4 Selection of Braking Resistor

Voltage (V)	Converter power (kW)	Brake resistor specification		Brake resistor	Braking torque 10%ED
		W	Ohm		
Single - phase 220 series	0.75	160	170	Ripple resistor	125%
	1.5	340	80	Ripple resistor	125%
	2.2	500	50	Ripple resistor	125%
	4.0	800	33	Ripple resistor	125%
	5.5	1300	22	Ripple resistor	125%
Three - phase 220 series	0.75	160	170	Ripple resistor	125%
	1.5	340	80	Ripple resistor	125%
	2.2	500	50	Ripple resistor	125%
	3.7	800	33	Ripple resistor	125%
	5.5	1300	22	Ripple resistor	125%
	7.5	1700	16	Ripple resistor	125%
	11	2300	12	Ripple resistor	125%
	15	3000	9	Ripple resistor	125%
	18.5	3900	7	Ripple resistor	125%
	22	4600	6	Ripple resistor	125%
	30	5500	5	Ripple resistor	125%
	37	6800	4	Ripple resistor	125%
	45	5000	5.4/2pcs	Ripple resistor	125%
	55	6000	4.4/2pcs	Ripple resistor	125%
Three - phase 380 series	0.75	100	750	Ripple resistor	125%
	1.5	300	400	Ripple resistor	125%
	2.2	400	250	Ripple resistor	125%
	3.7	600	150	Ripple resistor	125%
	5.5	1000	100	Ripple resistor	125%
	7.5	1300	75	Ripple resistor	125%
	11	2000	50	Ripple resistor	125%
	15	3000	38	Ripple resistor	125%
	18.5	4000	32	Ripple resistor	125%
	22	4000	25	Ripple resistor	125%
	30	5000	20	Ripple resistor	125%
	37	6000	16	Ripple resistor	125%
	45	4000	25/2pcs	Ripple resistor	125%
	55	5000	20/2pcs	Ripple resistor	125%
	75	6000	16/2pcs	Ripple resistor	125%
	93	5000	20/3pcs	Ripple resistor	125%
	110	6000	16/3pcs	Ripple resistor	125%
	132	11000	6.8/2pcs	Corrugated resistance box	125%
	160	13000	2.8/2pcs	Corrugated resistance box	125%
	185	13000	2.8/2pcs	Corrugated resistance box	125%
	200	16000	4.5/2pcs	Corrugated resistance box	125%
	220	17000	4.1/2pcs	Corrugated resistance box	125%
	250	20000	3.6/2pcs	Corrugated resistance box	125%
	280	22000	3.2/2pcs	Corrugated resistance box	125%
315	17000	4.3/3pcs	Corrugated resistance box	125%	
355	19000	3.8/3pcs	Corrugated resistance box	125%	
400	22000	3.4/3pcs	Corrugated resistance box	125%	
450	24000	3.0/3pcs	Corrugated resistance box	125%	
500	17000	4.1/4pcs	Corrugated resistance box	125%	

Note1 : The above table is the selection value under the condition of 125% braking torque, 10% braking frequency and maximum 10 seconds. If the braking frequency is large, the power of the braking unit should be increased accordingly. Typical values of braking frequency in different applications are listed in the following table.

Application	Elevator	Winding & unwinding	Centrifuge	Occasional braking load	General Application
Brake Frequency	20% to 30%	20% to 30%	50% to 60%	5%	10%

Note2 :

1. please select the resistance value specified by the company.
2. if the brake resistance provided by the company is used, and causes the inverter or other equipment to be damaged, the company shall not bear any responsibility.
3. the installation of brake resistance must consider the safety of the environment, flammability, distance inverter at least 100 mm.
4. the parameters in the table are for reference only and not as standard.

3. Basic Running Wiring

3.1 Basic Wiring Diagram

The wiring parts of VFD include major loop and control loop. Open the cover of I/O terminals, users can see the major loop terminal and control loop terminal, and must conduct the wiring according to the following diagram.

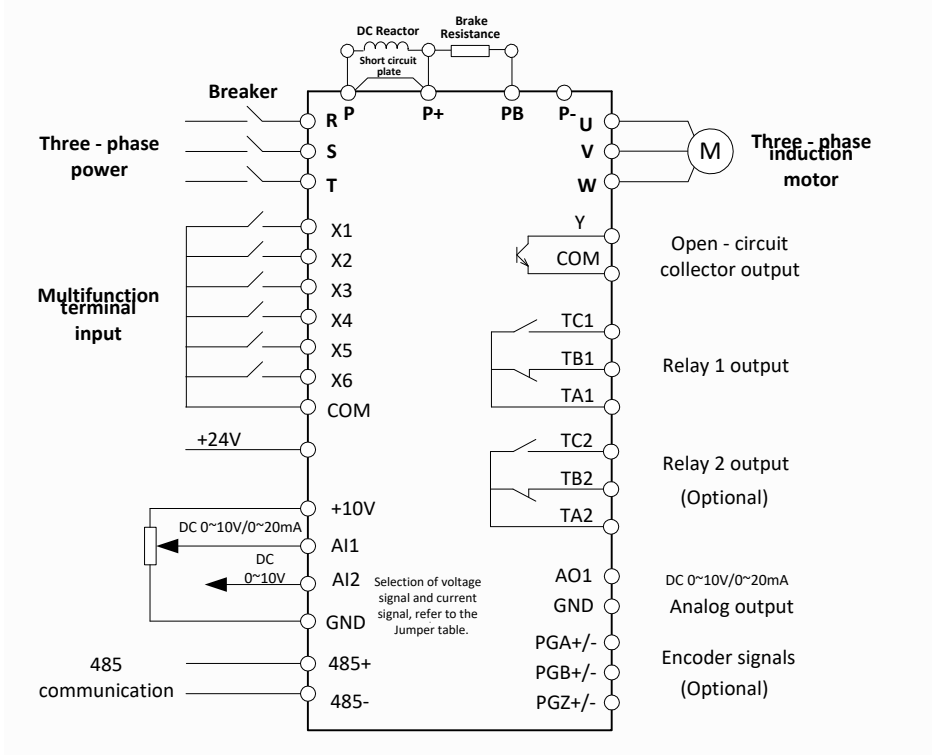

Figure 3-1 Basic operation diagram

3.2 Terminal of Main Loop

● Main loop terminal distribution description

This series of products have the following four main loop terminal distribution:

1) 0.75kW to 2.2kW AC 220V/380V/ 7.5kW AC 380V

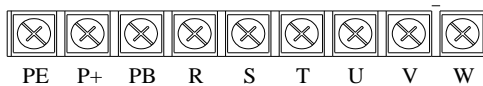

2) 4.0kW to 5.5kW/ 15kW to 18.5kW/ 22 kW AC 380V

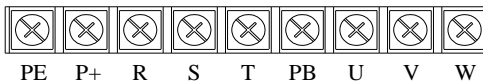

3) 11kW AC 380V

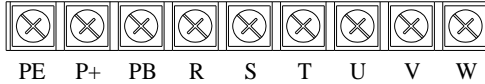

4) Above 30kW AC 380V

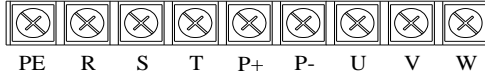

● Functional Specification of Main loop terminal

Terminal	Terminal Name	Function Description
PE	Ground	Grounding connection.
P+, P-	DC bus output terminal	Connected to external braking unit.
P-, P+	Reactor connection terminal	One end of the reactor is connected with P and the other end is connected with P+.
P+, PB	Brake resistance connection terminal	One end of the brake resistance is connected with P+, one end is connected with PB.
R, S, T	Three-phase power input terminal	AC 380V: Connected to power grid three-phase AC power supply (R, S, T) AC 220V: Connected to single-phase AC power supply (R, T)
U, V, W	Three-phase AC output terminal	Connected to a three-phase motor.

3.3 Terminal of Control Loop

● Control loop terminal distribution description



● Functional Specification of Control Loop Terminal

Category	Terminal Number	Functions	Specification
Multi-functional Digital Input Terminal	X1	Effective when short circuit between(X1、 X2、 X3、 X4、 X5) to COM, and the functions are set by parameters P4-00 to P4-04. (Common port: COM)	INPUT, 0 to 24V level signal, low level effective, 5mA.
	X2		
	X3		
	X4		
	X5		
	X6	X6 can work as one of the multi-functional terminals, also as high-speed pulse input terminal with programming(optional), see P4-28 to P4-32.	
Digital Output Terminal	Y	Y Can be set for high-speed pulse output (optional), also can be used as collector, the common end is COM; (Common port: COM) Set the high-speed pulse output through parameters P5-00 and P5-09.	OUTPUT, maximum load current ≤50mA.
Analog Input/Output	AI1	AI1 receives voltage/current input. Jumper CN400 (for jumper terminal AI1) can select voltage or current input mode, and voltage	INPUT, input voltage range: 0 to 10V (input impedance: 100KΩ), input current range 0 to 20mA.

Terminal		input is the default one. (Reference ground: GND)	(Input impedance: 500Ω)
	AI2	AI 2 only receives voltage input. (Reference ground: GND)	
	AO1	AO1 is able to output analog voltage/current. Jumper CN503 (for jumper terminal AO1) can select voltage or current output mode, and voltage output is the default one. For current input, just short the middle and another pin with the jumper cap, see P5-07. (Reference ground: GND)	OUTPUT, 0 to 10V DC voltage or 0 to 20 mA current Output. Voltage of AO1 came from PMW waveform of CPU. Output voltage is in direct proportion to the width of PWM waveform.
Relay Output Terminal	TA1	Programmatically defined as multifunctional relay output terminal, see P5-02 output terminal function description.	TA1-TB1: normal close; TA1-TC1: normal open. Contact compacity: 250V AC/2A (COSΦ=1); 250V AC/1A(COSΦ=0.4), 30V DC/1A.
	TB1		
	TC1		
Relay Output Terminal (Optional)	TA2	Programmatically defined as multifunctional relay output terminal, see P5-03 output terminal function description.	TA2-TB2: normal close; TA2-TC2: normal open. Contact compacity: 250V AC/2A (COSΦ=1); 250V AC/1A(COSΦ=0.4), 30V DC/1A.
	TB2		
	TC2		
Power Port	+24V	Digital signal input terminal circuit common power supply	Maximum output current 200mA
	+10V	Analog input/output terminals common circuit power supply	Maximum output current 20mA
	COM	Digital signal and +24V power reference ground	Internally is isolated from GND
	GND	Analog signal and +10V power reference ground	Internally isolated from COM
communication interface	485+	RS485 signal positive terminal	Standard RS485 communication port, not isolated from GND, use twisted pair cable or shielded cable.
	485-	RS485 signal negative terminal	

- Control terminal AI1 can input both voltage and current signal, while AI2 can only input voltage signal; users can conduct corresponding jumper on master control board according to signal type.
- Connecting weak analog signal is easily affected by external disturbance. So wiring should be as short as possible. The external control line should be set with isolating device or shielding line, and should be grounded.
- Input order signal line and frequency meter should be wired separately with shielding, and away from major loop wiring.
- Control loop wiring should be over 0.75 mm², and STP (shielded twisted pair) is recommended.
- control loop terminals should be enameled with tin, or process metal joint with cold pressing.
- While connecting analog signal output devices, malfunction may occur because of interference from VFD, which can be solved by fixing with capacitor or ferrite bead to the analog signal output device.

3.4 Dial Switch

CN200	
ON	The resistance of the matching on the 485 communication is not connected
OFF	The resistance of the matching on the 485 communication is connected
CN400	
Cin	Represents AI1 input current signal, 0 to 20mA
Vin	Represents AI1 input voltage signal, 0 to 10V
CN503	
Vo1	Represents AO1 output voltage signal, 0 to 10V
Co1	Represents AO1 output current signal, 0 to 20mA

3.5 Wiring Notices

- ① Cut off the input power of VFD while dismantling and changing the motor.
- ② Switching of motor or work frequency power supply should only be conducted when the VFD stops output.
- ③ To reduce the effect of EMI (electromagnetic interference), add a surge absorber when electromagnetic connector and relay are close to VFD.
- ④ Do not connect AC input power to output terminal U, V, W of VFD.
- ⑤ Add an isolating device to the external control line or use shield line.
- ⑥ Input order signal line should be wired separately with shielding, and away from major loop wiring.
- ⑦ When carrier frequency is less than 4kHz, keep the distance between VFD and motor within 50m; when carrier frequency exceeds 4kHz, make an appropriate reduction of the distance, and better lay the wire in metal tube.
- ⑧ When adding peripherals (filters, reactors, etc.) to the VFD, check the ground resistance with 1000V tramegger and ensure the value is above 4 MΩ.
- ⑨ Do not add phase advance capacitor or RC snubber to the U, V, W terminal of VFD.
- ⑩ If the VFD starts frequently, do not cut off the power, use the COM/RUN of control terminal to conduct start and stop so as not to damage the rectifier bridge.
- ⑪ The earth terminal must be grounded reliably (grounding impedance should be under 100 Ω) to avoid accidents, or there might be electric leakage.
- ⑫ Choose the wire diameter according to national electrical code while conducting major loop wiring.

Spare Circuit

It may cause big downtime loss or other accidental failure during VFD failure or tripping. Adding spare circuit is recommended under this circumstance to ensure safety. Note: confirm and test the operation characteristic of the spare circuit in advance to ensure the working frequency and the phase sequence of converted frequency are agreed.

4. Operation and Display

4.1 Instructions for operation panel

4.1.1 Operating Panel

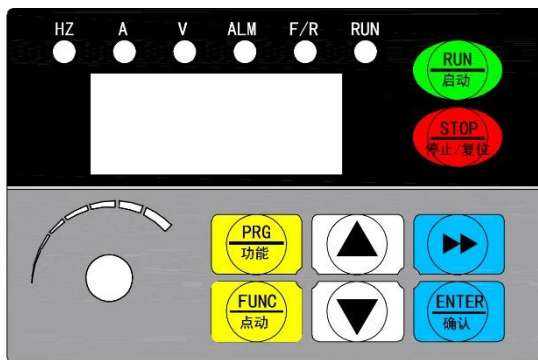

Figure 4-1 Schematic diagram of operating panel

As shown in the figure above, the user can set/modify the parameters of the inverter, monitor the working state, and control the operation (starting and stopping) through the operation panel.

4.1.2 Operating Panel Keys

Key	Name	Function Description
PRG	Programming/Escape key	Three-level menu operation mode: In the zero-level menu state, press this key to enter the level-1 menu. The non-zero level menu returns the previous level menu.
ENTER	Enter key	In level-1 and Level-2 menus, press this key to enter the next-level menu. Confirm setting parameters in three-level menu state.
▲	Increase key	Function code, menu group, or set parameter value increment
▼	Decrease key	Function code, menu group, or set parameter value decrement.
▶▶	Shift key	In zero-level menu state, the display parameters of operation/shutdown monitoring are cyclically switched; When setting data in programming state, you can change the modification bit of setting data.
RUN	Run key	Enter into run mode under keypad model.
STOP	Stop/Reset key	Used for shutdown operation during operation; Reset operation key in fault alarm state.
FUNC	Function key	Switch functions based on P7-01 Settings.

4.1.3 LED and Indicator Light Description

Indicator Name	Description
Hz	Frequency unit
A	Current unit
V	Voltage unit

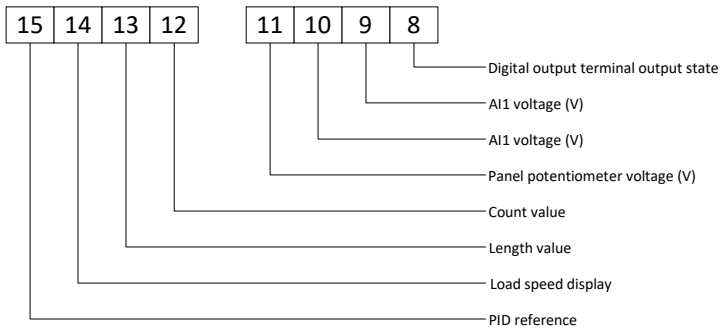

Figure 4-4 P7-03 Higher eight bits display content

Note: Shading parameter is set to display by default at factory.

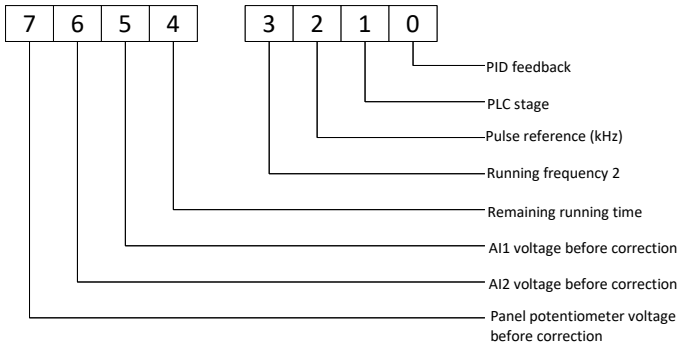

Figure 4-5 P7-04 Lower eight bits display content

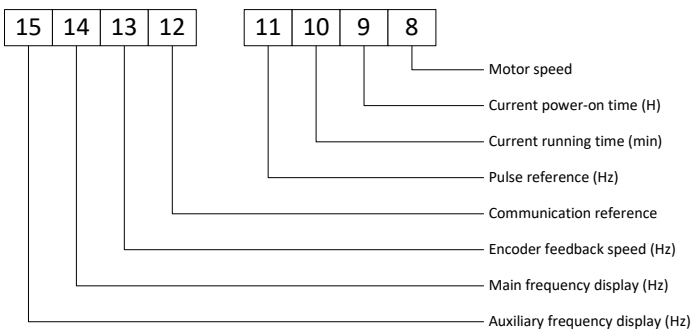

Figure 4-6 P7-04 Higher eight bits display content

2) State query in stop state

There are 16 status parameters available for query in the shutdown state, and the corresponding parameters of each parameter are determined by the function code P7-05(shutdown display parameters) according to the bits of binary.

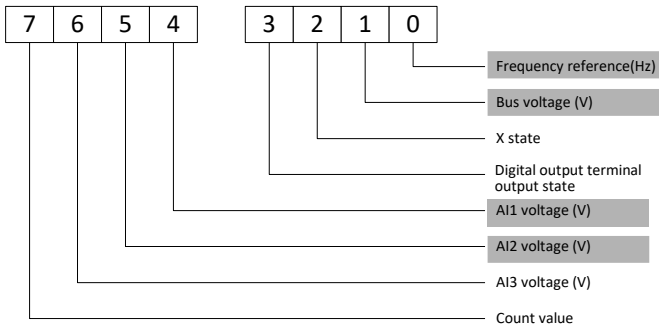

Figure 4-7 P7-05 Lower eight bits display content

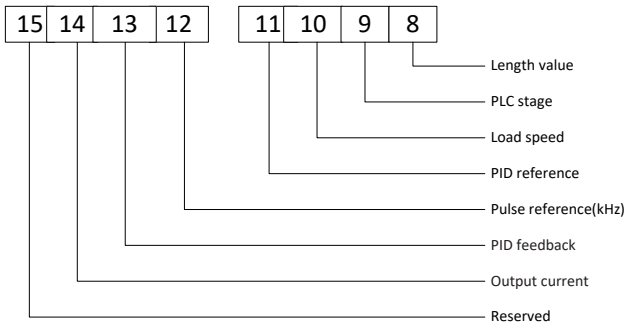

Figure 4-8 P7-05 Higher eight bits display content

Note: Shading parameter is set to display by default at factory.

4.2.3 Fault Alarm State

When the inverter is in the shutdown state, running state and programming state, if the fault is detected, the corresponding fault information will be reported immediately. At this point, the LED nixie tube flashes to show the fault code. When a fault occurs, you can press the PRG key to enter the programming menu and query fault status record parameters.

When a fault alarm occurs, press the STOP/RESET key to RESET the fault after switching to the alarm display. If the fault disappears, the system returns to the normal state. If the fault persists, the fault code is displayed again.

4.3 Operating Panel Operation Method

4.3.1 Set the Parameters

Correct setting of inverter parameters is the premise of giving full play to its performance. Taking motor rated power as an example (changing 7.5kW motor parameters to 5.5kW motor parameters), the parameter setting method of inverter operation panel is introduced.

The operation process is shown in the figure below. Press the shift key to switch the parameter flicker bit (that is, change bit), the key has the function of one-way circular shift. After parameters are set, press the program button twice to exit the program state.

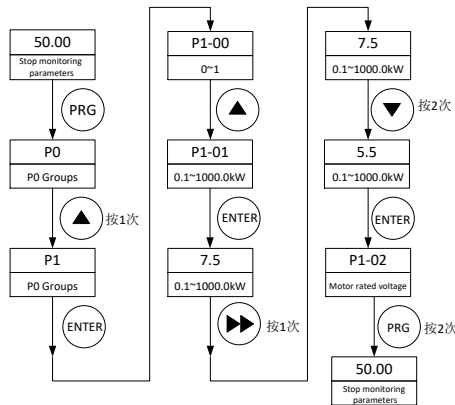

Figure 4-9 Flowchart for setting parameters

4.4 Automatic Tuning of Motor Parameters

Before selecting the vector control operation mode, the user should accurately input the nameplate parameters of the motor: P1-01 to P1-05. The above parameters of the inverter match the standard motor parameters. In order to obtain better control performance, the motor parameters self-learning process needs to be implemented to obtain accurate parameters of the controlled motor.

The following is a 7.5kW inverter driving 7.5kW three-phase asynchronous AC motor as an example to explain the basic control process. Nameplate parameters of the motor are: Rated power: 7.5kW; Rated voltage: 380V; Rated current: 17.0A; Rated frequency: 50Hz; Rated speed: 1440 rpm; Use the operation panel to set the frequency, start, forward, stop the operation process:

- (1) According to the wiring diagram, check that the wiring is correct, then power on the inverter;
- (2) Press PRG to enter the programming menu;
- (3) Set motor automatic tuning.
 - a) Set parameter P1-01, set the rated power of the motor to 7.5kW, and press ENTER to confirm;
 - b) Set parameter P1-02, set the rated voltage of the motor to 380V, and press ENTER to confirm;
 - c) Set parameter P1-03, set the rated current of the motor to 17.0A, and press ENTER to confirm;
 - d) Set parameter P1-04, set the rated frequency of the motor to 50.00Hz, and press ENTER to confirm;
 - e) Set parameter P1-05, set the rated speed of the motor to 1440rpm, and press ENTER to confirm;
 - f) Set parameter P1-37 and set it to 3 (Asynchronous motor complete static auto-tuning), press ENTER to confirm and tune;
 - g) Press the RUN key to automatically tune.

Note:

- When the motor and load can be detached, full-tuning is recommended (P1-37=2). Otherwise, static tuning (P1-37=3) is performed;
- A static tuning process works for a certain amount of time, with the motor standing still (static), but the inverter has an output voltage, which stops when the tuning is complete. During tuning, the keyboard displays "TUNE";
- When tuning fully, the electricity rotates, taking longer time and with more accurate parameters, paying attention to the safety of people and equipment at this time.
- During tuning, users can press the STOP button to STOP tuning if something abnormal happens, and retune the tuning process after the abnormality is removed.

4.5 Vector Control Mode Parameter Settings

After parameter identification, set the following function parameters of the inverter;

- (1) Enter P0-02, set it to 0, and select the keyboard to run the command control mode.
- (2) Enter P0-03 parameter, set it to 0, and select the main frequency setting mode as digital setting;
- (3) Enter P0-01, set it to 0, and select speed Sensorless Vector control (SVC) as the control mode;

- (4) Enter P0-08 and set the set frequency to 30.00Hz;
- (5) Press PRG to exit the programming state and return to the shutdown state;
- (6) Press RUN once to start the inverter;
- (7) During operation, press the up and down key to modify the current set frequency of the inverter;
- (8) Press STOP once to slow down the motor until it stops running.

5. Standard Parameter Table

PP-00 is the user password setting parameter: when this value is not zero, the user must enter the password correctly to enter the function parameter and user change parameter mode; to cancel the user password, set PP -00 to zero.

The user password is only used to lock the panel. After the password is set, you need to enter the password when you log out of the panel and enter the password when you log in to the panel again. Read and write operations (except PP and PF groups) are performed without passwords.

Attribute symbols in the parameter list are described as follows:

: It is possible to modify the parameter with the inverter in the Stop and in the Run status.

+ : It is not possible to modify the parameter with the inverter in the Run status.

* : The parameter is the actual measured value and cannot be modified.

Note: Group P and Group d are basic function parameters, and Group U is monitoring function parameters.

No.	Param. Name	Setting Range	Default	Change
Group P0: Basic Run Parameters				
P0-00	G/P type display	1: G (constant torque load) 2: P (fan and pump)	Model dependent	+
P0-01	Motor 1 control mode	0: SVC 1: FVC 2: V/F	2	+
P0-02	Running command selection	0: Operating panel 1: Terminal 2: Serial communication	0	#
P0-03	Main frequency reference setting channel selection	0: Digital setting (revised value is cleared after power off) 1: Digital setting (revised value is not cleared after power off) 2: AI1 analog set (0 to 10V/20mA) 3: AI2 analog set (0 to 10V) 4: Panel potentiometer setting 5: Pulse setting (enable only for X6) 6: Multi-reference 7: Simple PLC 8: PID reference 9: Communication setting	4	+
P0-04	Auxiliary frequency reference setting channel selection	Same as P0-03 (Main frequency reference setting channel selection)	0	+
P0-05	Base value of range of auxiliary frequency reference for Main and auxiliary calculation	0: Relative to maximum frequency 1: Relative to main frequency reference	0	#
P0-06	Range of auxiliary frequency reference for main and auxiliary calculation	0% to 150%	100%	#
P0-07	Final Frequency reference setting selection	Tens: main and auxiliary calculation formula 0: Main + auxiliary 1: Main - auxiliary 2: Max. (main, auxiliary)	00	#

		3: Min. (main, auxiliary) Ones: Frequency reference selection 0: Main frequency reference 1: Main and auxiliary calculation (based on tens position) 2: Switchover between main and auxiliary 3: Switchover between main and "main & auxiliary calculation" 4: Switchover between auxiliary and "main & auxiliary calculation"		
P0-08	Preset frequency	0.00 Hz to P0-10 (Max. frequency)	50.00 Hz	#
P0-09	Running direction	0: Forward run 1: Reverse run	0	#
P0-10	Max. frequency	50.00 Hz to 500.00 Hz(P0-22=2) 50.0 Hz to 3200.0 Hz(P0-22=1)	50.00 Hz	+
P0-11	Setting channel of frequency upper limit	0: Set by P0-12 (Frequency reference upper limit) 1: AI1 2: AI2 3: Panel potentiometer setting 4: Pulse reference 5: Communication reference	0	+
P0-12	Frequency reference upper limit	P0-14 (Frequency reference lower limit) to P0-10 (Max. frequency)	50.00 Hz	#
P0-13	Frequency reference upper limit offset	0.00 Hz to P0-10 (Max. frequency)	0.00 Hz	#
P0-14	Frequency reference lower limit	0.00 Hz to P0-12 (Frequency reference upper limit)	0.00 Hz	#
P0-15	Carrier frequency	Model dependent (Unit :kHz)	Model dependent	#
P0-16	Carrier frequency adjusted with load	0: Disabled 1: Enabled	1	#
P0-17	Acceleration time 1	0.00s to 650.00s(P0-19 = 2) 0.0s to 6500.0s(P0-19 = 1) 0s to 65000s(P0-19 = 0)	Model dependent	#
P0-18	Deceleration time 1	0.00s to 650.00s(P0-19 = 2) 0.0s to 6500.0s(P0-19 = 1) 0s to 65000s(P0-19 = 0)	Model dependent	#
P0-19	Acceleration/ Deceleration time unit	0: 1s 1: 0.1s 2: 0.01s	1	+
P0-21	Frequency offset of auxiliary frequency setting channel for main and auxiliary calculation	0.00 Hz to P0-10 (Max. frequency)	0.00 Hz	#
P0-22	High frequency mode enable	1: Enabled 2: Disabled	2	+
P0-23	Retentive of digital setting frequency upon stop	0: Not retentive 1: Retentive	0	#
P0-24	Motor parameter group selection	0: Motor parameter group 1 1: Motor parameter group 2	0	+
P0-25	Acceleration/	0: Maximum frequency (P0-10)	0	+

	Deceleration time base frequency	1: Frequency reference 2: 100 Hz		
P0-26	Base frequency for UP/DOWN modification during running	0: Running frequency 1: Frequency reference	0	+
P0-27	Running command + frequency source	Hundreds: serial communication +frequency reference setting channel Tens: terminal I/O control + frequency reference setting channel Ones: operating panel (keypad & display) + frequency reference setting channel 0: No function 1: Digital setting 2: AI1 3: AI2 4: Panel potentiometer setting 5: Pulse reference (X6) 6: Multi-reference 7: Simple PLC 8: PID reference 9: Serial communication	000	#
Group P1: Motor 1 Parameters				
P1-00	Motor type selection	0: Common asynchronous motor 1: Variable frequency asynchronous motor	0	+
P1-01	Rated motor power	0.1 kW to 1000.0 kW	Model dependent	+
P1-02	Rated motor voltage	1 V to 2000 V	Model dependent	+
P1-03	Rated motor current	0.01 A to 655.35 A (inverter power \leq 55 kW) 0.1 A to 6553.5 A (inverter power $>$ 55 kW)	Model dependent	+
P1-04	Rated motor frequency	0.01 Hz to max. frequency	Model dependent	+
P1-05	Rated motor speed	1 rpm to 65535 rpm	Model dependent	+
P1-06	Stator resistance	0.001 Ω to 65.535 Ω (inverter power \leq 55 kW) 0.0001 Ω to 6.5535 Ω (inverter power $>$ 55 kW)	Auto- tuning parameter	+
P1-07	Rotor resistance	0.001 Ω to 65.535 Ω (inverter power \leq 55 kW) 0.0001 Ω to 6.5535 Ω (inverter power $>$ 55 kW)	Auto- tuning parameter	+
P1-08	Leakage inductive reactance	0.01 mH to 655.35 mH (inverter power \leq 55 kW) 0.001 mH to 65.535 mH (inverter power $>$ 55 kW)	Auto- tuning parameter	+
P1-09	Mutual inductive reactance	0.1 mH to 6553.5 mH (inverter power \leq 55 kW) 0.01 mH to 655.35 mH (inverter power $>$ 55 kW)	Auto- tuning parameter	+
P1-10	No-load current	0.01 A to P1-03 (inverter power \leq 55 kW) 0.1 A to P1-03 (inverter power $>$ 55 kW)	Auto- tuning parameter	+

P1-27	Encoder pulses per revolution	1 to 65535	1024	+
P1-28	Encoder type	0: ABZ incremental encoder	0	+
P1-30	A/B phase sequence of ABZ incremental encoder	0: Forward 1: Reverse	0	+
P1-34	Number of pole pairs of resolver	1 to 65535	1	+
P1-36	Encoder wire-break fault detection time	0.0s: No detection 0.1s to 10.0s	0.0s	+
P1-37	Auto-tuning selection	0: No auto-tuning 1: Asynchronous motor partial static auto-tuning 2: Asynchronous motor dynamic auto-tuning 3: Asynchronous motor complete static auto-tuning	0	+
Group P2: Vector Control Parameters of Motor 1				
P2-00	Speed loop proportional gain 1	1 to 100	30	#
P2-01	Speed loop integral time 1	0.01s to 10.00s	0.50s	#
P2-02	Switchover frequency 1	0.00 to P2-05 (Switchover frequency 2)	5.00 Hz	#
P2-03	Speed loop proportional gain 2	1 to 100	20	#
P2-04	Speed loop integral time 2	0.01s to 10.00s	1.00s	#
P2-05	Switchover frequency 2	P2-02 (Switchover frequency 1) to maximum frequency	10.00 Hz	#
P2-06	Vector control slip compensation gain	50% to 200%	100%	#
P2-07	Speed feedback filter time in SVC	0.000s to 0.100s	0.015s	#
P2-09	Torque limit source in speed control	0: P2-10 1: AI1 2: AI2 3: Panel potentiometer setting 4: Pulse reference (X6) 5: Serial comms. 6: Min. (AI1, AI2) 7: Max. (AI1, AI2) The full scale of 1-7 corresponds to P2-10.	0	#
P2-10	Digital setting of torque limit in speed control	0.0% to 200.0%	150.0%	#
P2-11	Torque limit source in speed control (regenerative)	0: P2-10 (electrical or regenerative) 1: AI 2: AI2 3: Panel potentiometer setting 4: Pulse reference 5: Communication reference 6: Min. (AI1, AI2) 7: Max. (AI1, AI2)	0	#

		8: P2-12 The full scale of 1-7corresponds to P2-12.		
P2-12	Digital setting of torque limit in speed control (regenerative)	0.0% to 200.0%	150.0%	#
P2-13	Excitation adjustment proportional gain	0 to 60000	2000	#
P2-14	Excitation adjustment integral gain	0 to 60000	1300	#
P2-15	Torque adjustment proportional gain	0 to 60000	2000	#
P2-16	Torque adjustment integral gain	0 to 60000	1300	#
P2-17	Speed loop integral separation selection	0: Disabled 1: Enabled	0	#
P2-21	Max. torque coefficient of field weakening area	50 to 200%	100%	#
P2-22	Regenerative power limit selection	0: Disabled 1: Enabled	0	#
P2-23	Regenerative power limit	0.0 to 200.0%	Model dependent	#
Group P3: V/F Control Parameters				
P3-00	V/F curve setting	0: Linear V/F 1: Multi-point V/F 2-9: Reserved 10: V/F complete separation mode 11: V/F half separation mode	0	+
P3-01	Torque boost	0.0% to 30.0%	Model dependent	#
P3-02	Cut-off frequency of torque boost	0.00 Hz to the maximum frequency	50.00 Hz	+
P3-03	Multi-point V/F frequency 1	0.00 Hz to P3-05 (Multi-point V/F frequency 2)	0.00 Hz	+
P3-04	Multi-point V/F voltage 1	0.0% to 100.0%	0.0%	+
P3-05	Multi-point V/F frequency 2	P3-03 (Multi-point V/F frequency 1) to P3-07 (Multi-point V/F frequency 3)	0.00 Hz	+
P3-06	Multi-point V/F voltage 2	0.0% to 100.0%	0.0%	+
P3-07	Multi-point V/F frequency 3	P3-05 (Multi-point V/F frequency 2) to P1-04 (rated motor frequency)	0.00 Hz	+
P3-08	Multi-point V/F voltage 3	0.0% to 100.0%	0.0%	+
P3-10	V/F over-excitation gain	0 to 200	64	#
P3-11	V/F oscillation suppression gain	0 to 100	40	#

P3-13	Voltage source for V/F separation	0: Digital setting(Set by P3-14) 1: AI1 2: AI2 3: Panel potentiometer setting 4: Pulse reference (X6) 5: Multi-reference 6: Simple PLC 7: PID reference 8: Serial comms. Note: 100.0% corresponds to the rated motor voltage	0	#
P3-14	Digital setting of voltage for V/F separation	0 V to rated motor voltage	0 V	#
P3-15	Voltage rise time of V/ F separation	0.0s to 1000.0s Note: It is the time used for the voltage increases from 0 V to the rated motor voltage.	0.0s	#
P3-16	Voltage decline time of V/F separation	0.0s to 1000.0s Note: It is the time used for the voltage increases from 0 V to the rated motor voltage.	0.0s	#
P3-17	Stop mode selection for V/F separation	0: Frequency and voltage declining to 0 independently 1: Frequency declining after voltage declines to 0	0	#
P3-18	Current limit level	50% to 200%	150%	+
P3-19	Current limit selection	0: Disabled 1: Enabled	1 (Enabled)	+
P3-20	Current limit gain	0 to 100	20	#
P3-21	Compensation factor of speed multiplying current limit	50% to 200%	50%	+
P3-22	Voltage limit	Three-phase 380 to 480V: 650.0 V to 800.0 V Default: 720.0 V One-phase 200 to 240V: 330.0 V to 420.0 V Default: 380.0 V	720.0 V	+
P3-23	Voltage limit selection	0: Disabled 1: Enabled	1 (Enabled)	+
P3-24	Frequency gain for voltage limit	0 to 100	30	#
P3-25	Voltage gain for voltage limit	0 to 100	30	#
P3-26	Frequency rise threshold during voltage limit	0 to 50 Hz	5 Hz	+
Group P4: Digital Input Parameters				
P4-00	Input terminal X1 function selection	0: No function 1: Forward RUN (FWD) or running command	1	+
P4-01	Input terminal X2 function selection	2: Reverse RUN (REV) or running direction (Note: P4-11 must be set when P4-00 is set to 1 or 2.)	2	+
P4-02	Input terminal X3 function selection	3: Three-wire control 4: Forward JOG (FJOG)	9	+
P4-03	Input terminal X4 function selection	5: Reverse JOG (RJOG) 6: Terminal UP	12	+
P4-04	Input terminal X5 function selection	7: Terminal DOWN	13	+

P4-05	Input terminal X6 function selection	8: Coast to stop 9: Fault reset (RESET) 10: RUN pause 11: External fault normally open (NO) input 12: Multi-reference terminal 1 13: Multi-reference terminal 2 14: Multi-reference terminal 3 15: Multi-reference terminal 4 16: Terminal 1 for acceleration/deceleration time selection 17: Terminal 2 for acceleration/deceleration time selection 18: Frequency source switchover 19: UP and DOWN setting clear (terminal, operating panel) 20: Running command switchover terminal 1 21: Acceleration/ Deceleration prohibited 22: PID pause 23: PLC status reset 24: Swing pause 25: Counter input 26: Counter reset 27: Length count input 28: Length reset 29: Torque control prohibited 30: Pulse input (enabled only for X6) 31: Reserved 32: Immediate DC injection braking 33: External fault normally closed (NC) input 34: Frequency modification enabled 35: PID action direction reverse 36: External STOP terminal 1 37: Running command switchover terminal 2 38: PID integral disabled 39: Switchover between main frequency source and preset frequency 40: Switchover between auxiliary frequency source and preset frequency 41: Motor terminal selection 42: Reserved 43: PID parameter switchover 44: User-defined fault 1 45: User-defined fault 2 46: Speed control/ Torque control switchover 47: Emergency stop 48: External STOP terminal 2 49: Deceleration DC injection braking 50: Clear the current running time 51: Two-wire/Three-wire mode switchover 52: Reverse frequency forbidden 53-59: Reserved	8	+
P4-10	Input terminal X1 to X6 filter time	0.000s to 1.000s	0.010s	#

P4-11	Terminal I/O control mode	0: Two-wire control mode 1 1: Two-wire control mode 2 2: Three-wire control mode 1 3: Three-wire control mode 2 4: Pulse button control start and stop	0	+
P4-12	Terminal UP/DOWN rate	0.001 Hz/s to 65.535 Hz/s	1.000Hz/s	#
P4-13	AI curve 1 min. input	0.00 V to P4-15 (AI curve 1 max. input)	0.00 V	#
P4-14	Corresponding percentage of AI curve 1 min. input	-100.0% to +100.0%	0.0%	#
P4-15	AI curve 1 max. input	P4-13 (AI curve 1 min. input) to 10.00 V	10.00 V	#
P4-16	Corresponding percentage of AI curve 1 max. input	-100.0% to +100.0%	100.0%	#
P4-17	AI1 filter time	0.00s to 10.00s	0.10s	#
P4-18	AI curve 2 min. input	0.00 V to P4-20 (AI curve 2 max. input)	0.00 V	#
P4-19	Corresponding percentage of AI curve 2 min. input	-100.0% to +100.0%	0.0%	#
P4-20	AI curve 2 max. input	P4-18 (AI curve 2 min. input) to 10.00 V	10.00 V	#
P4-21	Corresponding percentage of AI curve 2 max. input	-100.0% to +100.0%	100.0%	#
P4-22	AI2 filter time	0.00s to 10.00s	0.10s	#
P4-23	Panel potentiometer curve min. input	-10.00 V to P4-25 (AI curve 3 max. input)	-10.00 V	#
P4-24	Corresponding percentage of AI curve 3 min. input	-100.0% to +100.0%	-100.0%	#
P4-25	AI curve 3 max. input	P4-23 (Panel potentiometer curve min. input) to 10.00 V	10.00 V	#
P4-26	Corresponding percentage of AI curve 3 max. input	-100.0% to +100.0%	100.0%	#
P4-27	Panel potentiometer filter time	0.00s to 10.00s	0.50s	#
P4-28	Pulse min. input	0.00 kHz to P4-30 (Pulse max. input)	0.00 kHz	#
P4-29	Corresponding percentage of pulse min. input	-100.0% to 100.0%	0.0%	#
P4-30	Pulse max. input	P4-28 (Pulse min. input) to 100.00 kHz	50.00 kHz	#
P4-31	Corresponding percentage of pulse max. input	-100.0% to 100.0%	100.0%	#
P4-32	Pulse filter time	0.00s to 10.00s	0.10s	#
P4-33	AI curve selection	Ones: AI1 curve selection 1: Curve 1 (2 points, see P4-13 to P4-16) 2: Curve 2 (2 points, see P4-18 to P4-21)	121	#

		3: Curve 3 (2 points, see P4-23 to P4-26) 4: Curve 4 (4 points, see d6-00 to d6-07) 5: Curve 5 (4 points, see d6-08 to d6-15) Tens: AI2 curve selection, same as the ones position Hundreds: Panel potentiometer curve selection, same as the ones position		
P4-34	Setting selection when AI less than min. input	Ones: AI1 0: Corresponding percentage of min. input 1: 0.0% Tens: AI2, same as the ones position Hundreds: Panel potentiometer, same as the ones position	000	#
P4-35	X1 delay time	0.0s to 3600.0s	0.0s	+
P4-36	X2 delay time	0.0s to 3600.0s	0.0s	+
P4-37	X3 delay time	0.0s to 3600.0s	0.0s	+
P4-38	X1 to X5 active mode selection 1	Ones: X1 active mode 0: High level active 1: Low level active Tens: X2 active mode 0: High level active 1: Low level active Hundreds: X3 active mode 0: High level active 1: Low level active Thousands: X4 active mode 0: High level active 1: Low level active Ten Thousands: X5 active mode 0: High level active 1: Low level active	00000	+
P4-39	X6 active mode selection 2	Ones: X6 active mode 0: High level active 1: Low level active	0	+
P4-40	AI1 input mode selection	0: 0.00V to 10V input 1: 0.00mA to 20 mA input	0	+
Group P5: Digital Output Parameters				
P5-00	Y terminal output mode	0: Pulse output (FMP) (optional) 1: Digital output (FMR)	1	#
P5-01	Y terminal FMR function selection (open collector Output terminal)	0: No output 1: inverter running 2: Fault output (coast to stop) 3: Frequency-level detection FDT1 output	1	#
P5-02	Relay 1 function selection	4: Frequency reached 5: Zero-speed running (no output at stop)	2	#
P5-03	Relay 2 function selection (Optional accessories)	6: Motor overload pre-warning 7: inverter overload pre-warning 8: Set count value reached 9: Designated count value reached 10: Length reached 11: PLC cycle completed 12: Accumulative running time reached 13: Frequency limited 14: Torque limited 15: Ready for RUN 16: AI1 > AI2 17: Frequency upper limit reached	0	#

		18: Frequency lower limit reached (no output at stop) 19: Undervoltage status output 20: Communication setting 21: Reserved 22: Reserved 23: Zero-speed running 2 (having output at stop) 24: Accumulative power-on time reached 25: Frequency level detection FDT2 output 26: Frequency 1 reached 27: Frequency 2 reached 28: Current 1 reached 29: Current 2 reached 30: Timing duration reached 31: AI1 input limit exceeded 32: Load lost 33: Reverse running 34: Zero current status 35: IGBT temperature reached 36: Software current limit exceeded 37: Frequency lower limit reached (having output at stop) 38: Alarm output 39: Reserved 40: Current running time reached 41: Fault output (no output at undervoltage)		
P5-06	Y terminal FMP function selection	0: Running frequency 1: Set frequency 2: Output current 3: Output torque (absolute value, proportion to motor torque) 4: Output power 5: Output voltage 6: Pulse input (100.0% corresponds to 100.0 kHz) 7: AI1 8: AI2 9: Panel potentiometer 10: Length 11: Count value 12: Communication setting 13: Motor rotational speed 14: Output current (100.0% corresponds to 1000.0 A) 15: Output voltage (100.0% corresponds to 1000.0 V) 16: Output torque (actual value, proportion to motor torque)	0	#
P5-07	AO1 function selection			
P5-09	Y terminal Max. FMP output frequency	0.01 kHz to 100.00 kHz	50.00 kHz	#
P5-10	AO1 zero offset coefficient	-100.0% to +100.0%	0.0%	#
P5-11	AO1 gain	-10.00 to +10.00	1.00	#
P5-17	Y terminal FMR output delay time	0.0s to 3600.0s	0.0s	#
P5-18	Relay 1 output delay time	0.0s to 3600.0s	0.0s	#

P5-19	Relay 2 output delay time	0.0s to 3600.0s	0.0s	#
P5-22	Active mode selection of Digital output terminals	Ones: FMR active mode 0: Positive logic active 1: Negative logic active Tens: Relay1 active mode 0: Positive logic active 1: Negative logic active Hundreds: Relay2 active mode 0: Positive logic active 1: Negative logic active	00000	#
Group P6: Start/Stop Control Parameters				
P6-00	Start mode	0: Direct start 1: Catching a spinning motor 2: Pre-excited start (AC asynchronous drive) 3: SVC quick start	0	#
P6-01	Mode of catching a spinning motor	0: From stop frequency 1: From power frequency 2: From max. frequency	0	+
P6-02	Speed of catching a spinning motor	1 to 100	20	#
P6-03	Start frequency	0.00 Hz to 10.00 Hz	0.00 Hz	#
P6-04	Start frequency holding time	0.0s to 100.0s	0.0s	+
P6-05	DC injection braking level/Pre-excitation level	0% to 100%	50%	+
P6-06	DC injection braking active time/Pre-excitation active time	0.0s to 100.0s	0.0s	+
P6-07	Acceleration/Deceleration mode	0: Linear acceleration/deceleration 1-2: S-curve dynamic acceleration/deceleration	0	+
P6-08	Time proportion of S-curve startsegment	0.0% to (100.0% - P6-09)	30.0%	+
P6-09	Time proportion of S-curve end segment	0.0% to (100.0% - P6-08)	30.0%	+
P6-10	Stop mode	0: Decelerate to stop 1: Coast to stop	0	#
P6-11	DC injection braking start frequency	0.00 Hz to the maximum frequency	0.00 Hz	#
P6-12	DC injection braking delay time	0.0s to 100.0s	0.0s	#
P6-13	DC injection braking level	0% to 100%	50%	#
P6-14	DC injection braking active time	0.0s to 100.0s	0.0s	#
P6-15	Braking use ratio	0% to 100%	100%	#
P6-18	Catching a spinning motor current limit	30% to 200% (Motor rated current)	Model dependent	+
P6-21	Demagnetization time (effective for SVC)	0.00 to 5.00s	Model dependent	#

Group P7: Parameters of Operating Panel and Display				
P7-00	Reserved			*
P7-01	FUNC key function selection	0: FUNC key disabled 1: Switchover from remote control (terminal or communication) to operating panel control 2: Switchover between forward rotation and reverse rotation 3: Forward jog 4: Reverse jog 5: Reverse run	3	+
P7-02	STOP/RESET key function	0: STOP/RESET key enabled only in operating panel control 1: STOP/RESET key enabled in any operation mode	1	#
P7-03	LED display running parameters 1	0000 to FFFF Bit00: Running frequency 1 (Hz) Bit01: Set frequency (Hz) Bit02: Bus voltage (V) Bit03: Output voltage (V) Bit04: Output current (A) Bit05: Output power (kW) Bit06: Output torque (%) Bit07: X state Bit08: Reserved Bit09: AI1 voltage (V) Bit10: AI2 voltage (V) Bit11: Panel potentiometer voltage (V) Bit12: Count value Bit13: Length value Bit14: Load speed display Bit15: PID reference	1F	#
P7-04	LED display running parameters 2	0000 to FFFF Bit00: PID feedback Bit01: PLC stage Bit02: Pulse reference (kHz) Bit03: Running frequency 2 (Hz) Bit04: Remaining running time Bit05: AI1 voltage before correction (V) Bit06: AI2 voltage before correction (V) Bit07: Panel potentiometer voltage before correction (V) Bit08: Linear speed Bit09: Current power-on time (h) Bit10: Current running time (min) Bit11: Pulse reference (Hz) Bit12: Communication reference Bit13: Encoder feedback speed (Hz) Bit14: Main frequency A display (Hz) Bit15: Auxiliary frequency B display (Hz)	00	#

P7-05	LED display stop parameters	0000 to FFFF Bit00: Frequency reference (Hz) Bit01: Bus voltage (V) Bit02: X state Bit03: Reserved Bit04:AI1 voltage (V) Bit05:AI2 voltage (V) Bit06: Panel potentiometer voltage (V) Bit07: Count value Bit08: Length value Bit09: PLC stage Bit10: Load speed Bit11: PID reference Bit12: Pulse reference (kHz) Bit13: PID feedback Bit14: Output current Bit15: Reserved	33	#
P7-06	Load speed display coefficient	0.0001 to 6.5000	1.0000	#
P7-07	Heatsink temperature of IGBT	-30°C to 120°C	-	*
P7-08	Rectifier bridge temperature	-30°C to 120°C	-	*
P7-09	Accumulative running time	0 to 65535 h	-	*
P7-10	Performance software version	-	-	*
P7-11	Function software version	-	-	*
P7-12	Number of decimal places for load speed display	Tens: Number of decimal places for U0-19/U0-29 1: One decimal place 2: Two decimal places Ones: Number of decimal places for U0-14 0: No decimal place 1: One decimal place 2: Two decimal places 3: Three decimal places	21	#
P7-13	Accumulative power-on time	0 to 65535 h	-	*
P7-14	Accumulative power consumption	0 to 65535 kWh	-	*
Group P8: Auxiliary function parameters				
P8-00	Jog frequency reference	0.00 Hz to the maximum frequency	2.00 Hz	#
P8-01	Jog acceleration time	0.0s to 6500.0s	20.0s	#
P8-02	Jog deceleration time	0.0s to 6500.0s	20.0s	#
P8-03	Acceleration time 2	0.00s to 650.00s(P0-19=2) 0.0s to 6500.0s(P0-19=1) 0s to 65000s(P0-19=0)	Model dependent	#
P8-04	Deceleration time 2	0.00s to 650.00s(P0-19=2) 0.0s to 6500.0s(P0-19=1) 0s to 65000s(P0-19=0)	Model dependent	#

P8-05	Acceleration time 3	0.00s to 650.00s(P0-19=2) 0.0s to 6500.0s(P0-19=1) 0s to 65000s(P0-19=0)	Model dependent	#
P8-06	Deceleration time 3	0.00s to 650.00s(P0-19=2) 0.0s to 6500.0s(P0-19=1) 0s to 65000s(P0-19=0)	Model dependent	#
P8-07	Acceleration time 4	0.00s to 650.00s(P0-19=2) 0.0s to 6500.0s(P0-19=1) 0s to 65000s(P0-19=0)	Model dependent	#
P8-08	Deceleration time 4	0.00s to 650.00s(P0-19=2) 0.0s to 6500.0s(P0-19=1) 0s to 65000s(P0-19=0)	Model dependent	#
P8-09	Frequency jump 1	0.00 Hz to the maximum frequency	0.00 Hz	#
P8-10	Frequency jump 2	0.00 Hz to the maximum frequency	0.00 Hz	#
P8-11	Frequency jump band	0.00 Hz to the maximum frequency	0.00 Hz	#
P8-12	Forward/Reverse run switchover dead-zone time	0.0s to 3000.0s	0.0s	#
P8-13	Reverse RUN selection	0: Disabled 1: Enabled	0	#
P8-14	Running mode when frequency reference lower than frequency lower limit	0: Run at frequency reference lower limit 1: Stop 2: Run at zero speed	0	#
P8-15	Droop rate	0.00% to 100.00%	0.00%	#
P8-16	Accumulative power-on time threshold	0 to 65000 h	0 h	#
P8-17	Accumulative running time threshold	0 to 65000 h	0 h	#
P8-18	Startup protection selection	0: Disabled 1: Enabled	0	#
P8-19	Frequency detection value 1	0.00 Hz to the maximum frequency	50.00 Hz	#
P8-20	Frequency detection hysteresis 1	0.0% to 100.0% (FDT1 level)	5.0%	#
P8-21	Detection width of target frequency reached	0.0% to 100.0% (maximum frequency)	0.0%	#
P8-22	Jump frequency function	0: Disabled 1: Enabled	0	#
P8-25	Switchover frequency of acceleration time 1 and acceleration time 2	0.00 Hz to the maximum frequency	0.00 Hz	#
P8-26	Switchover frequency of deceleration time 1 and deceleration time 2	0.00 Hz to the maximum frequency	0.00 Hz	#
P8-27	Set highest priority to terminal JOG function	0: Disabled 1: Enabled	0	#
P8-28	Frequency detection value 2	0.00 Hz to the maximum frequency	50.00 Hz	#

P8-29	Frequency detection hysteresis 2	0.0% to 100.0% (FDT2 level)	5.0%	#
P8-30	Detection of frequency 1	0.00 Hz to the maximum frequency	50.00 Hz	#
P8-31	Detection width of frequency 1	0.0% to 100.0% (maximum frequency)	0.0%	#
P8-32	Detection of frequency 2	0.00 Hz to the maximum frequency	50.00 Hz	#
P8-33	Detection width of frequency 2	0.0% to 100.0% (maximum frequency)	0.0%	#
P8-34	Zero current detection level	0.0% to 300.0% 100.0% corresponds to the rated motor current.	5.0%	#
P8-35	Zero current detection delay	0.01s to 600.00s	0.10s	#
P8-36	Output overcurrent threshold	0.0% (no detection) 0.1% to 300.0% (rated motor current)	200.0%	#
P8-37	Output overcurrent detection delay	0.00s to 600.00s	0.00s	#
P8-38	Detection level of current 1	0.0% to 300.0% (rated motor current)	100.0%	#
P8-39	Detection width of current 1	0.0% to 300.0% (rated motor current)	0.0%	#
P8-40	Detection level of current 2	0.0% to 300.0% (rated motor current)	100.0%	#
P8-41	Detection width of current 2	0.0% to 300.0% (rated motor current)	0.0%	#
P8-42	Timing function	0: Disabled 1: Enabled	0	+
P8-43	Running time setting channel	0: Set by P8-44 (Running time) 1: AI1 2: AI2 3: Panel potentiometer setting (100% of analog input corresponds to the value of P8-44)	0	+
P8-44	Running time	0.0 min to 6500.0 min	0.0 min	+
P8-45	AI1 input voltage lower limit	0.00 V to P8-46 (AI1 input voltage upper limit)	3.10 V	#
P8-46	AI1 input voltage upper limit	0.00 V to P8-46 (AI1 input voltage upper limit)	6.80 V	#
P8-47	IGBT temperature threshold	0°C to 100°C	75°C	#
P8-48	Cooling fan working mode	0: Working during running 1: Working continuously	0	#
P8-53	Running time threshold this time	0.0min to 6500.0min	0.0 min	#
P8-54	Output power correction coefficient	0.00% to 200.0%	100.0%	#
Group P9: Parameters of Fault and Protection				
P9-00	Motor overload protection	0: Disabled 1: Enabled	1	#
P9-01	Motor overload protection gain	0.20 to 10.00	1.00	#

P9-02	Motor overload pre-warning coefficient	50% to 100%	80%	#
P9-03	Overvoltage protection gain	0 to 100	30	#
P9-04	Overvoltage protection voltage	Three-phase 380 to 480V: 650.0 V to 800.0 V Default: 720.0 V One-phase 200 to 240V: 330.0 V to 420.0 V Default: 380.0 V	720 V	+
P9-07	Detection of short-circuit to ground	Tens: Detection of short-circuit to ground before running 0: Disabled 1: Enabled Ones: Detection of short-circuit to ground upon power on 0: Disabled 1: Enabled	Model dependent	#
P9-08	Braking unit applied voltage	Three-phase 380 to 480V: 650.0 V to 800.0 V Default: 690.0 V One-phase 200 to 240V: 330.0 V to 420.0 V Default: 360.0 V	Model dependent	+
P9-09	Auto reset times	0 to 30	0	#
P9-10	Selection of digital output terminal action during auto reset	0: Not act 1: Act	1	#
P9-11	Delay of auto reset	0.1s to 100.0s	1.0s	#
P9-12	Input phase loss/ Contactor protection	Tens: Contactor protection 0: Disabled 1: Enabled Ones: Input phase loss protection 0: Disabled 1: Enabled	11	#
P9-13	Output phase loss protection	Tens: Output phase loss protection before running 0: Disabled 1: Enabled Ones: Output phase loss protection 0: Disabled 1: Enabled	01	#

P9-14	1st fault type	0: No fault 1: Reserved 2: Overcurrent during acceleration 3: Overcurrent during deceleration 4: Overcurrent at constant speed 5: Overvoltage during acceleration 6: Overvoltage during deceleration 7: Overvoltage at constant speed 8: Pre-charge power fault 9: Undervoltage 10: inverter overload 11: Motor overload 12: Input phase loss 13: Output phase loss 14: IGBT overheat 15: External fault 16: Communication fault 17: Contactor fault 18: Current detection fault 19: Motor auto-tuning fault 20: Encoder/PG card fault 21: Parameter read and write fault	—	*
P9-15	2nd fault type	22: inverter hardware fault	—	*
P9-16	3rd (latest) fault type	23: Motor short circuited to ground 24: Reserved 25: Reserved 26: Accumulative running time reached 27: User-defined fault 1 28: User-defined fault 2 29: Accumulative power-on time reached 30: Load lost 31: PID feedback lost during running 40: Fast current limit timeout 41: Motor switchover error during running 42: Too large speed deviation 43: Motor over-speed 45: Reserved 51: Reserved 55: Slave error in master-slave control	—	*
P9-17	Frequency upon 3rd (latest) fault	0.00 Hz to 655.35 Hz	0.00 Hz	*
P9-18	Current upon 3rd (latest) fault	0.00 A to 655.35 A	0.00 A	*
P9-19	Bus voltage upon 3rd (latest) fault	0.0 V to 6553.5 V	0.0 V	*
P9-20	Input terminal state upon 3rd (latest) fault	0 to 9999	0	*
P9-21	Output terminal state upon 3rd (latest) fault	0 to 9999	0	*
P9-22	inverter state upon 3rd (latest) fault	0 to 65535	0	*

P9-23	Power-on time upon 3rd (latest) fault	0s to 65535s	0s	*
P9-24	Running time upon 3rd (latest) fault	0.0s to 6553.5s	0.0s	*
P9-27	Frequency upon 2nd fault	0.00 Hz to 655.35 Hz	0.00 Hz	*
P9-28	Current upon 2nd fault	0.00 A to 655.35 A	0.00 A	*
P9-29	Bus voltage upon 2nd fault	0.0 V to 6553.5 V	0.0 V	*
P9-30	Digital output terminal state upon 2nd fault	0 to 9999	0	*
P9-31	Output terminal state upon 2nd fault	0 to 9999	0	*
P9-32	inverter state upon 2nd fault	0 to 65535	0	*
P9-33	Power-on time upon 2nd fault	0s to 65535s	0s	*
P9-34	Running time upon 2nd fault	0.0s to 6553.5s	0.0s	*
P9-37	Frequency upon 1st fault	0.00 Hz to 655.35 Hz	0.00 Hz	*
P9-38	Current upon 1st fault	0.00 A to 655.35 A	0.00 A	*
P9-39	Bus voltage upon 1st fault	0.0 V to 6553.5 V	0.0 V	*
P9-40	X state upon 1st fault	0 to 9999	0	*
P9-41	Output terminal state upon 1st fault	0 to 9999	0	*
P9-42	inverter state upon 1st fault	0 to 65535	0	*
P9-43	Power-on time upon 1st fault	0s to 65535s	0s	*
P9-44	Running time upon 1st fault	0.0s to 6553.5s	0.0s	*
P9-47	Fault protection action selection 1	Ten Thousands: Communication fault (F16) Thousands: External fault (F15) Hundreds: Output phase loss (F13) Tens: Input phase loss (F12) Ones: Motor overload (F11) 0: Coast to stop 1: Stop according to the stop mode 2: Continue to run	00000	#
P9-48	Fault protection action selection 2	Ten thousands: Accumulative running time reached (F26) Thousands: Motor overhear (F45) Hundreds: inverter overload fault selection (F10) 0: Coast to stop 1: De-rated running	00000	#

		Tens: EEPROM read-write fault (F21) 0: Coast to stop 1: Stop according to the stop mode Ones: Encoder fault (F20) 0: Coast to stop		
P9-49	Fault protection action selection 3	Ten thousands: PID feedback lost during running (F31) 0: Coast to stop 1: Stop according to the stop mode 2: Continue to run Thousands: Load lost (F30) 0: Coast to stop 1: Deceleration to stop 2: Continue to run at 7% of rated motor frequency and restore to the frequency reference if the load recovers Hundreds: Accumulative power-on time reached (F29) 0: Coast to stop 1: Stop according to the stop mode 2: Continue to run Tens: User-defined fault 2 (F28) 0: Coast to stop 1: Stop according to the stop mode 2: Continue to run Ones: User-defined fault 1 (F27) 0: Coast to stop 1: Stop according to the stop mode 2: Continue to run	00000	#
P9-50	Fault protection action selection 4	Hundreds: Reserved Tens: Motor overspeed (F43) Ones: Too large speed feedback error (F42) 0: Coast to stop 1: Stop according to the stop mode 2: Continue to run	00000	#
P9-54	Frequency selection for continuing to run upon fault	0: Current running frequency 1: Frequency reference 2: Frequency upper limit 3: Frequency lower limit 4: Backup frequency upon abnormality	0	#
P9-55	Backup frequency upon fault	0.0% to 100.0% (100.0% corresponds to P0-10.)	100.0%	#
P9-59	Power dip ride-through function selection	0: Disabled 1: Bus voltage constant control 2: Decelerate to stop	0	+
P9-60	Threshold of power dip ride-through function disabled	80% to 100%	85%	+
P9-61	Judging time of bus voltage recovering from power dip	0.0 to 100.0s	0.5S	+

P9-62	Threshold of power dip ride-through function enabled	60% to 100%	80%	+
P9-63	Load lost protection	0: Disabled 1: Enabled	0	#
P9-64	Load lost detection level	0.0 to 100.0%	10.0%	#
P9-65	Load lost detection time	0.0 to 60.0s	1.0s	#
P9-67	Overspeed detection level	0.0% to 50.0% (maximum frequency)	20.0%	#
P9-68	Overspeed detection time	0.0s: Not detected 0.1s to 60.0s	1.0s	#
P9-69	Detection level of speed error	0.0% to 50.0% (maximum frequency)	20.0%	#
P9-70	Detection time of speed error	0.0s: Not detected 0.1 to 60.0s	5.0s	#
P9-71	Power dip ride-through gain Kp	0 to 100	40	#
P9-72	Power dip ride-through integral coefficient Ki	0 to 100	30	#
P9-73	Deceleration time of power dip ride-through	0 to 300.0s	20.0s	+
Group PA: PID Control Parameters				
PA-00	PID reference setting channel	0: Set by PA-01 (PID digital setting) 1: AI1 2: AI2 3: Panel potentiometer 4: Pulse reference (X6) 5: Serial comms. 6: Multi-reference	0	#
PA-01	PID digital setting	0.0 to PA-04	5.00	#
PA-02	PID feedback setting channel	0: AI1 1: AI2 2: Panel potentiometer 3: AI1-AI2 4: Pulse reference (X6) 5: Serial comms. 6: AI1 + AI2 7: Max. (AI1 , AI2) 8: Min. (AI1 , AI2)	0	#
PA-03	PID operation direction	0: Forward 1: Reverse	0	#
PA-04	PID reference and feedback range	1.00 to 655.35	10.00	#
PA-05	Proportional gain Kp1	0.0 to 1000.0	100.0	#
PA-06	Integral time Ti1	0.01s to 10.00s	0.50s	#
PA-07	Differential time Td1	0.000s to 10.000s	0.000s	#

PA-08	PID output limit in reverse direction	0.00 Hz to the maximum frequency	0.00 Hz	#
PA-09	PID error limit	0.0% to 100.0%	0.0%	#
PA-10	PID differential limit	0.00% to 100.00%	0.10%	#
PA-11	PID reference change time	0.00 to 650.00s	0.00s	#
PA-12	PID feedback filter time	0.00 to 60.00s	0.00s	#
PA-13	PID output filter time	0.00 to 60.00s	0.00s	#
PA-14	Stop mode in hibernating state	0: Decelerate to stop 1: Coast to stop	0	#
PA-15	Proportional gain Kp2	0.0 to 1000.0	20.0	#
PA-16	Integral time Ti2	0.01s to 10.00s	2.00s	#
PA-17	Differential time Td2	0.000s to 10.000s	0.000s	#
PA-18	PID parameter switchover condition	0: No switchover 1: Switchover using X 2: Auto switchover based on PID error 3: Auto switchover based on running frequency	0	#
PA-19	PID error 1 for auto switchover	0.0% to PA-20 (PID error 2 for auto switchover)	20.0%	#
PA-20	PID error 2 for auto switchover	PA-19 (PID error 1 for auto switchover) to 100.0%	80.0%	#
PA-21	PID initial value	0.0% to 100.0%	0.0%	#
PA-22	PID initial value active time	0.00 to 650.00s	0.00s	#
PA-23	Reserved	-	-	#
PA-24	Reserved	-	-	#
PA-25	PID integral property	Tens: Whether to stop integral operation when the PID output reaches the limit 0: Continue integral operation 1: Stop integral operation Ones: Integral separation 0: Disabled 1: Enabled	00	#
PA-26	Detection level of PID feedback loss	0.0%: No detection 0.1% to 100.0%	0.0%	#
PA-27	Detection time of PID feedback loss	0.0s to 20.0s	0.0s	#
PA-28	Selection of PID operation at stop	0: Disabled 1: Enabled	0	#
PA-29	Hibernating frequency	0.00Hz to Max. frequency (P0-10)	0.00Hz	#
PA-30	Hibernating pressure	PA-32 to 100.0% (Setting pressure)	95.0%	#
PA-31	Hibernating delay time	0.0 to 6500.0s	30.0s	#
PA-32	Wakeup pressure	0.0 to PA-30 (Hibernating pressure)	80.0%	#
PA-33	Wakeup delay time	0.0 to 6500.0s	3.0s	#
PA-34	Water shortage detection frequency	0.00Hz to Max. frequency (P0-10)	48.00Hz	#

PA-35	Water shortage detection pressure	0.00 to PA-04	0.00	#
PA-36	Water shortage detection time	0 to 65000s	60s	#
PA-37	Water shortage restart time	0 to 65000s	600s	#
PA-38	Water shortage restart times	0 to 9999	6	#
Group Pb: Parameters of Wobble Function, Fixed Length and Count				
Pb-00	Wobble setting mode	0: Relative to central frequency 1: Relative to max. frequency	0	#
Pb-01	Wobble amplitude	0.0% to 100.0%	0.0%	#
Pb-02	Wobble step	0.0% to 50.0%	0.0%	#
Pb-03	Wobble cycle	0.0s to 3000.0s	10.0s	#
Pb-04	Triangular wave rising time	0.0% to 100.0%	50.0%	#
Pb-05	Set length	0 m to 65535 m	1000m	#
Pb-06	Actual length	0 m to 65535 m	0m	#
Pb-07	Number of pulses per meter	0.1 to 6553.5	100.0	#
Pb-08	Set count value	1 to 65535	1000	#
Pb-09	Designated count value	1 to 65535	1000	#
Group PC: Parameters of Multi-Reference and Simple PLC Function				
PC-00	Reference 0	-100.0% to 100.0%	0.0%	#
PC-01	Reference 1	-100.0% to 100.0%	0.0%	#
PC-02	Reference 2	-100.0% to 100.0%	0.0%	#
PC-03	Reference 3	-100.0% to 100.0%	0.0%	#
PC-04	Reference 4	-100.0% to 100.0%	0.0%	#
PC-05	Reference 5	-100.0% to 100.0%	0.0%	#
PC-06	Reference 6	-100.0% to 100.0%	0.0%	#
PC-07	Reference 7	-100.0% to 100.0%	0.0%	#
PC-08	Reference 8	-100.0% to 100.0%	0.0%	#
PC-09	Reference 9	-100.0% to 100.0%	0.0%	#
PC-10	Reference 10	-100.0% to 100.0%	0.0%	#
PC-11	Reference 11	-100.0% to 100.0%	0.0%	#
PC-12	Reference 12	-100.0% to 100.0%	0.0%	#
PC-13	Reference 13	-100.0% to 100.0%	0.0%	#
PC-14	Reference 14	-100.0% to 100.0%	0.0%	#
PC-15	Reference 15	-100.0% to 100.0%	0.0%	#
PC-16	Simple PLC running mode	0: Stop after running one cycle 1: Keep final values after running one cycle 2: Repeat after running one cycle	0	#
PC-17	Simple PLC retentive selection	Tens: Retentive at stop 0: Not retentive at stop 1: Retentive at stop Ones: Retentive at power down 0: Not retentive 1: Retentive	00	#

PC-18	Running time of simple PLC reference 0	0.0s (h) to 6553.5s (h)	0.0s (h)	#
PC-19	Acceleration/ Deceleration time of simple PLC reference 0	0 to 3	0	#
PC-20	Running time of simple PLC reference 1	0.0s (h) to 6553.5s (h)	0.0s (h)	#
PC-21	Acceleration/ Deceleration time of simple PLC reference 1	0 to 3	0	#
PC-22	Running time of simple PLC reference 2	0.0s (h) to 6553.5s (h)	0.0s (h)	#
PC-23	Acceleration/ Deceleration time of simple PLC reference 2	0 to 3	0	#
PC-24	Running time of simple PLC reference 3	0.0s (h) to 6553.5s (h)	0.0s (h)	#
PC-25	Acceleration/ Deceleration time of simple PLC reference 3	0 to 3	0	#
PC-26	Running time of simple PLC reference 4	0.0s (h) to 6553.5s (h)	0.0s (h)	#
PC-27	Acceleration/ Deceleration time of simple PLC reference 4	0 to 3	0	#
PC-28	Running time of simple PLC reference 5	0.0s (h) to 6553.5s (h)	0.0s (h)	#
PC-29	Acceleration/ Deceleration time of simple PLC reference 5	0 to 3	0	#
PC-30	Running time of simple PLC reference 6	0.0s (h) to 6553.5s (h)	0.0s (h)	#
PC-31	Acceleration/ Deceleration time of simple PLC reference 6	0 to 3	0	#
PC-32	Running time of simple PLC reference 7	0.0s (h) to 6553.5s (h)	0.0s (h)	#
PC-33	Acceleration/ Deceleration time of simple PLC reference 7	0 to 3	0	#
PC-34	Running time of simple PLC reference 8	0.0s (h) to 6553.5s (h)	0.0s (h)	#
PC-35	Acceleration/ Deceleration time of simple PLC reference 8	0 to 3	0	#
PC-36	Running time of simple PLC reference 9	0.0s (h) to 6553.5s (h)	0.0s (h)	#
PC-37	Acceleration/ Deceleration time of simple PLC reference 9	0 to 3	0	#

PC-38	Running time of simple PLC reference 10	0.0s (h) to 6553.5s (h)	0.0s (h)	#
PC-39	Acceleration/ Deceleration time of simple PLC reference10	0 to 3	0	#
PC-40	Running time of simple PLC reference 11	0.0s (h) to 6553.5s (h)	0.0s (h)	#
PC-41	Acceleration/ Deceleration time of simple PLC reference 11	0 to 3	0	#
PC-42	Running time of simple PLC reference 12	0.0s (h) to 6553.5s (h)	0.0s (h)	#
PC-43	Acceleration/ Deceleration time of simple PLC reference12	0 to 3	0	#
PC-44	Running time of simple PLC reference 13	0.0s (h) to 6553.5s (h)	0.0s (h)	#
PC-45	Acceleration/ Deceleration time of simple PLC reference13	0 to 3	0	#
PC-46	Running time of simple PLC reference 14	0.0s (h) to 6553.5s (h)	0.0s (h)	#
PC-47	Acceleration/ Deceleration time of simple PLC reference14	0 to 3	0	#
PC-48	Running time of simple PLC reference 15	0.0s (h) to 6553.5s (h)	0.0s (h)	#
PC-49	Acceleration/ Deceleration time of simple PLC reference15	0 to 3	0	#
PC-50	Time unit of simple PLC running	0: s 1: h	0	#
PC-51	Reference 0 source	0: Set by PC-00(Reference 0) 1: AI1 2: AI2 3: Panel potentiometer setting 4: Pulse reference 5: PID 6: Set by preset frequency (P0-08), modified using terminal UP/DOWN	0	#
Group Pd: Communication Parameters				
Pd-00	Baud rate	Thousands: Reserved Hundreds: Reserved Tens: Reserved Ones: MODBUS 0: 300 bps 1: 600 bps 2: 1200 bps 3: 2400 bps 4: 4800 bps	5005	#

		5: 9600 bps 6: 19200 bps 7: 38400 bps 8: 57600 bps 9: 115200 bps		
Pd-01	Modbus data format symbol	0: No check (8,N,2) 1: Even parity check (8,E,1) 2: Odd parity check(8,O,1) 3: No check, data format(8,N,1) (Valid for Modbus)	3	#
Pd-02	Local address	0: Broadcast address; 1 to 247	1	#
Pd-03	Modbus response delay	0 to 20 ms (Valid for Modbus)	2	#
Pd-04	Serial port communication timeout	0.0: Disabled 0.1 to 60.0	0.0	#
Pd-05	Modbus protocol selection and PROFIBUS-DP data frame	Ones: Modbus 0: Non-standard Modbus protocol 1: Standard Modbus protocol	1	#
Pd-06	Current resolution read by communication	0: 0.01 A (valid when ≤ 55 kW) 1: 0.1 A	0	#
Group PE: User-Defined Parameters				
PE-00	User-defined parameter 0	P0-00toPP-xx d0-00todC-xx U0-00toU0-xx U3-00toU3-xx	U3-17	#
PE-01	User-defined parameter 1		U3-18	#
PE-02	User-defined parameter 2		P0-00	#
PE-03	User-defined parameter 3		P0-00	#
PE-04	User-defined parameter 4		P0-00	#
PE-05	User-defined parameter 5		P0-00	#
PE-06	User-defined parameter 6		P0-00	#
PE-07	User-defined parameter 7		P0-00	#
PE-08	User-defined parameter 8		P0-00	#
PE-09	User-defined parameter 9		P0-00	#
PE-10	User-defined parameter 10		P0-00	#
PE-11	User-defined parameter 11		P0-00	#
PE-12	User-defined parameter 12		P0-00	#

PE-13	User-defined parameter 13		P0-00	#
PE-14	User-defined parameter 14		P0-00	#
PE-15	User-defined parameter 15		P0-00	#
PE-16	User-defined parameter 16		P0-00	#
PE-17	User-defined parameter 17		P0-00	#
PE-18	User-defined parameter 18		P0-00	#
PE-19	User-defined parameter 19		P0-00	#
PE-20	User-defined parameter 20		U0-68	#
PE-21	User-defined parameter 21		U0-69	#
PE-22	User-defined parameter 22		P0-00	#
PE-23	User-defined parameter 23		P0-00	#
PE-24	User-defined parameter 24		P0-00	#
PE-25	User-defined parameter 25	P0-00toPP-xx	P0-00	#
PE-26	User-defined parameter 26	d0-00to dC-xx U0-00to U0-xx	P0-00	#
PE-27	User-defined parameter 27	U3-00to U3-xx	P0-00	#
PE-28	User-defined parameter 28		P0-00	#
PE-29	User-defined parameter 29		P0-00	#
Group PP: User Password Parameters				
PP-00	User password	0 to 65535	0	#
PP-01	Parameter initialization	0: No operation 01: Restore factory parameters except motor parameters 02: Clear records 03: Restore factory parameters including motor parameters 04: Back up current user parameters 501: Restore user backup parameters	0	+
PP-02	Parameter display property	Tens: Group d 0: Not displayed 1: Displayed Ones: Group U 0: Not displayed 1: Displayed	11	+

PP-03	Selection of individualized parameter display	Tens: Selection of user-modified parameter display 0: Not displayed 1: Displayed Ones: Selection of user-defined parameter display 0: Not displayed 1: Displayed	00	#
PP-04	Selection of parameter modification	0: Disabled 1: Enabled	0	#
Group d0: Parameters of Torque Control and Limit				
d0-00	Speed/Torque control selection	0: Speed control 1: Torque control	0	+
d0-01	Torque reference source in torque control	0: Set by d0-03 1: AI1 2: AI2 3: Panel potentiometer setting 4: Pulse reference 5: Communication reference 6: Min. (AI1, AI2) 7: Max. (AI1, AI2) The full scale of 1-7 corresponds to d0-03.	0	+
d0-03	Torque digital setting in torque control	-200.0% to 200.0%	150.0%	#
d0-05	Forward max. frequency in torque control	0.00 Hz to the maximum frequency	50.00 Hz	#
d0-06	Reverse max. frequency in torque control	0.00 Hz to the maximum frequency	50.00 Hz	#
d0-07	Acceleration time in torque control	0.00s to 650.00s	0.00s	#
d0-08	Deceleration time in torque control	0.00s to 650.00s	0.00s	#
Group d2: Motor 2 Parameters				
d2-00	Motor type selection	0: Common asynchronous motor 1: Variable frequency asynchronous motor	0	+
d2-01	Rated motor power	0.1 kW to 1000.0 kW	Model dependent	+
d2-02	Rated motor voltage	1 V to 2000 V	Model dependent	+
d2-03	Rated motor current	0.01 A to 655.35 A (inverter power \leq 55 kW) 0.1 A to 6553.5 A (inverter power $>$ 55 kW)	Model dependent	+
d2-04	Rated motor frequency	0.01 Hz to the maximum frequency	Model dependent	+
d2-05	Rated motor speed	1 rpm to 65535 rpm	Model dependent	+
d2-06	Stator resistance	0.001 Ω to 65.535 Ω (inverter power \leq 55 kW) 0.0001 Ω to 6.5535 Ω (inverter power $>$ 55 kW)	Model dependent	+
d2-07	Rotor resistance	0.001 Ω to 65.535 Ω (inverter power \leq 55 kW) 0.0001 Ω to 6.5535 Ω (inverter power $>$ 55 kW)	Model dependent	+

d2-08	Leakage inductive reactance	0.01 mH to 655.35 mH (inverter power \leq 55 kW) 0.001 mH to 65.535 mH (inverter power $>$ 55 kW)	Model dependent	+
d2-09	Mutual inductive reactance	0.1 mH to 6553.5 mH (inverter power \leq 55 kW) 0.01 mH to 655.35 mH (inverter power $>$ 55 kW)	Model dependent	+
d2-10	No-load current	0.01 A to d2-03 (inverter power \leq 55 kW) 0.1 A to d2-03 (inverter power $>$ 55 kW)	Model dependent	+
d2-27	Encoder pulses per revolution	1 to 65535	1024	+
d2-28	Encoder type	0: ABZ incremental encoder 2: Resolver	0	+
d2-29	Speed feedback channel selection	0: Local PG card 1: Extension PG card 2: Pulse input (X6)	0	+
d2-30	A/B phase sequence of ABZ incremental encoder	0: Forward 1: Reverse	0	+
d2-36	Encoder wire-break fault detection time	0.0s: No detection 0.1s to 10.0s	0.0	+
d2-37	Auto-tuning selection	0: No auto-tuning 1: Asynchronous motor partial static auto-tuning 2: Asynchronous complete dynamic auto-tuning 3: Asynchronous complete static auto-tuning	0	+
d2-38	Speed loop proportional gain 1	1 to 100	30	#
d2-39	Speed loop integral time 1	0.01s to 10.00s	0.50s	#
d2-40	Switchover frequency 1	0.00 to d2-43 (Switchover frequency 2)	5.00 Hz	#
d2-41	Speed loop proportional gain 2	1 to 100	20	#
d2-42	Speed loop integral time 2	0.01s to 10.00s	1.00s	#
d2-43	Switchover frequency 2	d2-40 (Switchover frequency 1) to the maximum frequency	10.00 Hz	#
d2-44	Vector control slip compensation gain	50% to 200%	100%	#
d2-45	SVC torque filter constant	0.000s to 0.100s	0.015s	#
d2-47	Torque limit source in speed control	0: Set by d2-48 (Digital setting of torque limit in speed control) 1: AI1 2: AI2 3: Panel potentiometer setting 4: Pulse reference 5: Communication reference 6: Min. (AI1, AI2) 7: Max. (AI1, AI2) The full scale of 1-7 corresponds to d2-48.	0	#

d2-48	Digital setting of torque limit in speed control	0.0% to 200.0%	150.0%	
d2-49	Torque limit source in speed control (regenerative)	0: Set by d2-48 (Digital setting of torque limit in speed control) 1: AI1 2: AI2 3: Panel potentiometer setting 4: Pulse setting 5: Communication setting 6: Min. (AI1, AI2) 7: Max. (AI1, AI2) 8: Set by d2-50 [Digital setting of torque limit in speed control (regenerative)] The full scale of 1-7 corresponds to d2-50.	0	#
d2-50	Digital setting of torque limit in speed control (regenerative)	0.0% to 200.0%	150.0%	#
d2-51	Excitation adjustment proportional gain	0 to 60000	2000	#
d2-52	Excitation adjustment integral gain	0 to 60000	1300	#
d2-53	Torque adjustment proportional gain	0 to 60000	2000	#
d2-54	Torque adjustment integral gain	0 to 60000	1300	#
d2-55	Speed loop integral separation selection	Ones: Integral separation 0: Disabled 1: Enabled	0	#
d2-59	Max. torque coefficient of field weakening area	50% to 200%	100%	#
d2-60	Regenerative power limit selection	0: Disabled 1: Enabled	0	#
d2-61	Regenerative power limit	0.0 to 200.0%	Model dependent	#
d2-62	Motor 2 control mode	0: SVC 1: FVC 2: V/F control	0	+
d2-63	Motor 2 acceleration/ deceleration time selection	0,1: Same to Motor 1 2: Acceleration/ Deceleration time selection 2 3: Acceleration/ Deceleration time selection 3 4: Acceleration/Deceleration time selection 4	2	#
d2-64	Motor 2 torque boost	0.0% to 30.0%	Model dependent	#
d2-65	Motor 2 oscillation suppression gain	0 to 100	40	#

Group d5: Control Optimization Parameters				
d5-00	DPWM switchover frequency upper limit	5.00 Hz to the maximum frequency	8.00 Hz	#
d5-01	PWM modulation pattern	0: Asynchronous modulation 1: Synchronous modulation	0	#
d5-02	Dead zone compensation mode selection	0: Disabled 1: Enabled (Compensation mode 1)	1	#
d5-03	Random PWM depth	0: Random PWM invalid 1 to 10: Random PWM	0	#
d5-04	Overcurrent fast prevention	0: Disabled 1: Enabled	0	#
d5-05	Voltage over modulation coefficient	100 to 110	105	+
d5-06	Undervoltage threshold	Three-phase 380 to 480V: 330.0 V to 420.0 V Default: 350.0 V One-phase 200 to 240V: 160.0 V to 330.0 V Default: 200.0 V	Model dependent	#
d5-09	Overvoltage threshold	Three-phase 380 to 480V: 650.0 V to 820.0 V Default: 810.0 V One-phase 200 to 240V: 200.0 V to 420.0 V Default: 400.0 V	Model dependent	+
Group d6: Parameters of AI Curve Setting				
d6-00	AI curve 4 min. input	-10.00 V to d6-02 (AI curve 4 inflection 1 input)	0.00 V	#
d6-01	Corresponding percentage of AI curve 4 min. input	-100.0% to +100.0%	0.0%	#
d6-02	AI curve 4 inflection 1 input	d6-00 (AI curve 4 min. input) to d6-04 (AI curve 4 inflection 2 input)	3.00 V	#
d6-03	Corresponding percentage of AI curve 4 inflection 1 input	-100.0% to +100.0%	30.0%	#
d6-04	AI curve 4 inflection 2 input	d6-02 (AI curve 4 inflection 1 input) to d6-06 (AI curve 4 max. input)	6.00 V	#
d6-05	Corresponding percentage of AI curve 4 inflection 2 input	-100.0% to +100.0%	60.0%	#
d6-06	AI curve 4 max. input	d6-04 (AI curve 4 inflection 2 input) to +10.00 V	10.00 V	#
d6-07	Corresponding percentage of AI curve 4 max. input	-100.0% to +100.0%	100.0%	#
d6-08	AI curve 5 min. input	-10.00 V to d6-10 (AI curve 5 inflection 1 input)	-10.00 V	#
d6-09	Corresponding percentage of AI curve 5 min. input	-100.0% to +100.0%	-100.0%	#
d6-10	AI curve 5 inflection 1 input	d6-08 (AI curve 5 min. input) to d6-12 (AI curve 5 inflection 2 input)	-3.00 V	#
d6-11	Corresponding percentage of AI curve 5 inflection 1 input	-100.0% to +100.0%	-30.0%	#

d6-12	AI curve 5 inflection 2 input	d6-10 (AI curve 5 inflection 1 input) to d6-14 (AI curve 5 max. input)	3.00 V	#
d6-13	Corresponding percentage of AI curve 5 inflection 2 input	-100.0% to +100.0%	30.0%	#
d6-14	AI curve 5 max. input	d6-12 (AI curve 5 inflection 2 input) to +10.00 V	10.00 V	#
d6-15	Corresponding percentage of AI curve 5 max. input	-100.0% to +100.0%	100.0%	#
d6-24	Jump point of AI1 input corresponding setting	-100.0% to 100.0%	0.0%	#
d6-25	Jump amplitude of AI1 input corresponding setting	0.0% to 100.0%	0.5%	#
d6-26	Jump point of AI2 input corresponding setting	-100.0% to 100.0%	0.0%	#
d6-27	Jump amplitude of AI2 input corresponding setting	0.0% to 100.0%	0.5%	#
d6-28	Jump point of Panel potentiometer input corresponding setting	-100.0% to 100.0%	0.0%	#
d6-29	Jump amplitude of Panel potentiometer input corresponding setting	0.0% to 100.0%	0.5%	#
Group d9: Control Parameters of Photovoltaic Water Pump				
d9-00	Photovoltaic water pump operation mode	0: Enabled 1: MPPT control mode 1 2: MPPT control mode 2	0	#
d9-01	MPPT high operating voltage	d9-02 to 1000.0V	Model dependent	#
d9-02	MPPT low operating voltage	0.0V to d9-01	Model dependent	#
d9-03	Undervoltage restart function select	0: Disabled 1: Enabled	0	#
d9-04	Undervoltage restart delay time	0.0s to 360.0s	10.0s	#
d9-05	Restart function Select after power-on	0: Disabled 1: Enabled	0	#
d9-06	Minimum operating frequency of PV water pump	0.00Hz to P0-12	0.00Hz	#
d9-07	The water shortage detection current of photovoltaic water pump corresponds to the proportion of no-load current	80.0% to 300.0%	150.0%	#

d9-08	Water shortage detection time of PV water pump	0.0s (No detection) 0.1s to 250.0s	0.0s	#
d9-09	Photovoltaic water pump bus voltage regulation difference	0.0V (No adjustment) 0.1V to 20.0V	1.5V	#
Group dC: AI/AO Correction Parameters				
dC-00	AI1 measured voltage 1	-10.00 V to 10.000 V	Factory-corrected	#
dC-01	AI1 displayed voltage 1	-10.00 V to 10.000 V	Factory-corrected	#
dC-02	AI1 measured voltage 2	-10.00 V to 10.000 V	Factory-corrected	#
dC-03	AI1 displayed voltage 2	-10.00 V to 10.000 V	Factory-corrected	#
dC-04	AI2 measured voltage 1	-10.00 V to 10.000 V	Factory-corrected	#
dC-05	AI2 displayed voltage 1	-10.00 V to 10.000 V	Factory-corrected	#
dC-06	AI2 measured voltage 2	-10.00 V to 10.000 V	Factory-corrected	#
dC-07	AI2 displayed voltage 2	-10.00 V to 10.000 V	Factory-corrected	#
dC-08	Panel potentiometer measured voltage 1	-15.00 V to 15.000 V	Factory-corrected	#
dC-09	Panel potentiometer displayed voltage 1	-15.00 V to 15.000 V	Factory-corrected	#
dC-10	Panel potentiometer measured voltage 2	-15.00 V to 15.000 V	Factory-corrected	#
dC-11	Panel potentiometer displayed voltage 2	-15.00 V to 15.000 V	Factory-corrected	#
dC-12	AO1 target voltage 1	-20.00 V to 20.000 V	Factory-corrected	#
dC-13	AO1 measured voltage 1	-20.00 V to 20.000 V	Factory-corrected	#
dC-14	AO1 target voltage 2	-20.00 V to 20.000 V	Factory-corrected	#
dC-15	AO1 measured voltage 2	-20.00 V to 20.000 V	Factory-corrected	#

Monitoring Parameters

No.	Param. Name	Minimum Unit	Communication Address
Group U0: Monitoring Parameters			
U0-00	Running frequency	0.01 Hz	7000H
U0-01	Frequency reference	0.01 Hz	7001 H
U0-02	Bus voltage	0.1 V	7002H
U0-03	Output voltage	1 V	7003H
U0-04	Output current	0.01 A	7004H
U0-05	Output power	0.1 kW	7005H
U0-06	Output torque	0.1%	7006H
U0-07	input terminal state	1	7007H
U0-08	Reserved	-	7008H
U0-09	AI1 voltage/current	0.01 V/0.01 mA	7009H
U0-10	AI2 voltage	0.01 V	700AH
U0-11	Panel potentiometer voltage	0.01 V	700BH
U0-12	Count value	1	700CH
U0-13	Length value	1	700DH
U0-14	Load speed	1 rpm/min	700EH
U0-15	PID reference	0.01	700FH
U0-16	PID feedback	0.01	7010H
U0-17	PLC stage	1	7011 H
U0-18	Pulse reference	0.01 kHz	7012H
U0-19	Feedback speed	0.01 Hz	7013H
U0-20	Remaining running time	0.1 min	7014H
U0-21	AI1 voltage/current tbefore correction	0.001 V/0.01 mA	7015H
U0-22	AI2 voltage before correction	0.001 V	7016H
U0-23	Panel potentiometer voltage before correction	0.001 V	7017H
U0-24	Motor speed	1 rpm/min	7018H
U0-25	Current power-on time	1 min	7019H
U0-26	Current running time	0.1 min	701AH
U0-27	Pulse reference	1 Hz	701BH
U0-28	Communication reference	0.01%	701CH
U0-29	Encoder feedback speed	0.01 Hz	701DH
U0-30	Main frequency reference	0.01 Hz	701EH
U0-31	Auxiliary frequency reference	0.01 Hz	701FH
U0-32	Viewing any register address value	1	7020H

U0-34	Reserved	-	7022H
U0-35	Target torque	0.1%	7023H
U0-36	Reserved	-	7024H
U0-37	Power factor angle	0.1°	7025H
U0-38	ABZ position	1	7026H
U0-39	Target voltage upon V/F separation	1 V	7027H
U0-40	Output voltage upon V/F separation	1 V	7028H
U0-41	input terminal state display	1	7029H
U0-42	Reserved	-	702AH
U0-43	input terminal set for function state display 1 (function 01-40)	1	702BH
U0-44	input terminal set for function state display 2 (function 41-80)	1	702CH
U0-45	Fault information	1	702DH
U0-58	Phase Z counting	1	703AH
U0-59	Rated frequency	0.01%	703BH
U0-60	Running frequency	0.01%	703CH
U0-61	inverter state	1	703DH
U0-62	Current fault code	1	703EH
U0-63	Reserved	-	703FH
U0-64	Number of slaves	1	7040H
U0-65	Torque upper limit	0.1%	7041 H
U0-73	Motor SN	0: Motor 1; 1: Motor 2	7046H
U0-74	inverter output torque	0.1%	7047H

6. Detailed Explanation of Parameters

P0 Group - Basic Run Parameters

P0-00	G/P type display	
	1 to 2	1

1: G type (constant torque load type)

2: P type (fan and pump)

For our VFD products, G/P type are combined, i.e. G type inverter can be used as P type inverter with power of one grade higher.

P0-01	Motor 1 control mode	
	0 to 2	2

0: SVC

Open loop vector control is suitable for general high performance applications, such as machine tools, conveyor belts and other loads. In this mode, a inverter can only carry one motor, and the rated power, current and other parameters of the motor should be correctly input.

1: FVC

The closed-loop vector control with encoder is suitable for high precision speed or torque control applications. In this mode, a inverter can only carry one motor, and the motor parameters should be input correctly.

2: V/F control

This control mode is used when there is a need to drive one more motors with a single inverter and there is no access to the parameters of controlled motor. This control mode is most commonly used and applied in any circumstance where no strict requirement is needed for the motor control performance.

P0-02	Running command selection	
	0 to 2	0

0: Operating panel

Keypad run command channel Controlled with keys in keypad like RUN, STOP/RESET, FUNC.

1: Terminal

Terminal run command channel Controlled by Multi-function terminals defined as FWD, REV, JOG forward, JOG reverse.

2: Serial communication

Communication run command channel Controlled with communication method via upper computer.

P0-03	Main frequency reference setting channel selection	
	0 to 9	4

0: Digital setting (revised value is cleared after power off)

The frequency can be adjust with key ▲、▼ or UP/DOWN multi-function input terminal. The modified frequency value will be saved to P0-08 after power down.

1: Digital setting (revised value is not cleared after power off)

When the inverter is powered on again after power-off, the frequency is set to the set value at the time of last power-off.

2: AI1 analog set (0 to 10V/20mA)

The frequency setting is determined by analog voltage/current of AI1 terminal, and the input range DC 0 to 10V/20mA. Please refer to P4 group related parameter description.

3: AI2 analog set (0 to 10V)

Frequency setting is determined by analog voltage/current of AI2 terminal, input ranges DC 0 to 10V. Please refer to P4 group related parameter description.

4: Panel potentiometer setting

Parameters such as frequency are set by keyboard potentiometer, please refer to P4 group related parameter description.

5: Pulse setting (enable only for X6)

The frequency is set by terminal X6. The voltage range of the pulse is 9V to 30V, and please refer to P4 group related parameter description.

6: Multi-reference

When selecting this frequency setting mode, you need to set the corresponding input terminal to Multi-segment speed selection (see related parameters of P4 Group) and the definition of each segment speed and frequency of the PC group.

7: Simple PLC

The inverter runs in the program mode defined by the PC group parameters.

8: PID control setting

The frequency setting is controlled by the process PID. At this time, the related parameter function code of PA group needs to be set. The frequency set by the inverter is the frequency value after the PID function.

9: Communication setting

Set the running frequency of the inverter through RS485 serial communication command.

P0-04	Auxiliary frequency reference setting channel selection	
	0 to 9	0

Auxiliary frequency specified channel has the same meaning of each item as principle frequency channel, for details check P0-03 description.

P0-05	Base value of range of auxiliary frequency reference for Main and auxiliary calculation	
	0 to 1	0

0: Relative to maximum frequency

1: Relative to main frequency reference

P0-06	Range of auxiliary frequency reference for main and auxiliary calculation	
	0% to 150%	100%

If auxiliary frequency reference is set via analog input (AI1, AI2 and Panel potentiometer) or pulse reference, 100% of the input corresponds to range of the auxiliary frequency reference.

P0-07	Final Frequency reference setting selection	
	0 to 34	00

Tens	Ones
------	------

Frequency reference selection
 0: Main frequency reference
 1: Main and auxiliary calculation (based on tens position)
 2: Switchover between main and auxiliary
 3: Switchover between main and "main & auxiliary calculation"
 4: Switchover between auxiliary and "main & auxiliary calculation"

main and auxiliary calculation formula
 0: Main + auxiliary
 1: Main - auxiliary
 2: Max. (main, auxiliary)
 3: Min. (main, auxiliary)

P0-08	Preset frequency	
	0.00 Hz to P0-10 (Max. frequency)	50.00 Hz

When the main frequency setting is keypad digit setting or UP/DOWN setting, the value of this function code is the initial value of the current frequency.

P0-09	Running direction	
	0 to 1	0

0: forward run

In this mode, the actual output phase sequence is the same with system default. Key for forward control.

1: reverse run

In this mode, the actual output phase sequence is opposite to the system default. Key for reverse control.

P0-10	Max. frequency	
	50.00 Hz to 500.00 Hz	50.00 Hz

P0-11	Setting channel of frequency upper limit	
	0 to 5	0
P0-12	Frequency reference upper limit	
	P0-14 (Frequency reference lower limit) to P0-10 (Max. frequency)	50.00 Hz
P0-13	Frequency reference upper limit offset	
	0.00 Hz to P0-10 (Max. frequency)	0.00 Hz
P0-14	Frequency reference lower limit	
	0.00 Hz to P0-12 (Frequency reference upper limit)	0.00 Hz

P0-10 (Max. frequency) is the maximum output frequency allowed by the inverter. See f_{max} in Figure 7-1. P0-11 is the source of the upper limit frequency, which can be P0-12, AI1, AI2, keyboard potentiometer, etc. P0-12 (Frequency reference upper limit) is the maximum frequency allowed by the user, see f_H in Figure 7-1. P0-13 (Frequency reference upper limit offset) is the lowest frequency allowed by users, see f_L in Figure 7-1.

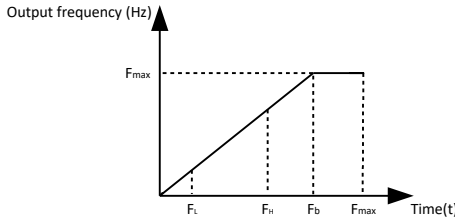

Figure 6-1 Schematic diagram of frequency range related parameters definition

P0-15	Carrier frequency	
	Model dependent	Model dependent

This function is mainly used to improve the noise and vibration phenomenon that may occur during operation. Because this series inverter adopts IGBT module as the main switching device, the available carrier frequency is high. When the carrier frequency is higher, the current waveform is ideal, and the motor noise is low, which is very suitable for places requiring silence. However, with the increase of carrier frequency, the switching loss of the main components increases, and the whole machine has more heat, lower efficiency and lower output. At the same time, the radio interference is large, especially in the high EMI requirements should be paid attention to, if necessary, filter options can be used. Another problem in the use of high carrier frequency is the increase of capacitive leakage current, leakage protector may cause its misoperation, may also cause the occurrence of overcurrent.

In the case of low carrier frequency, it is generally contrary to the above phenomenon, too low carrier frequency will increase motor noise. Different motors also respond differently to the carrier frequency. Therefore, the optimal carrier frequency needs to be adjusted according to the actual situation.

P0-16	Carrier frequency adjusted with load	
	0 to 1	1

0: Disabled

1: Enabled

P0-17	Acceleration time 1	
	0 to 2	Model dependent
P0-18	Deceleration time 1	
	0 to 2	Model dependent
P0-19	Acceleration/ Deceleration time	
	0 to 2	1
P0-21	Frequency offset of auxiliary frequency setting channel for main and auxiliary calculation	
	0.00 Hz to P0-10 (Max. frequency)	0.00 Hz

Acceleration time indicates time required by the inverter to accelerate from 0 Hz to acceleration/deceleration time base frequency (P0-25).

Deceleration time indicates time required by the inverter to decelerate from acceleration/deceleration time base frequency (P0-25) to 0 Hz.

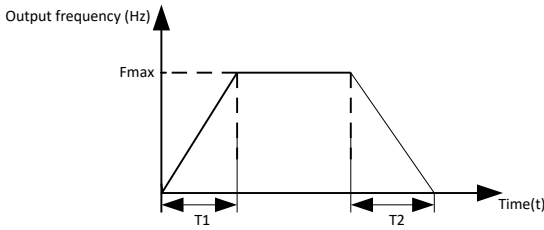

Figure 6-2 Definition of acceleration/deceleration time

P0-22	High frequency mode enable	
	1 to 2	0

1: Enabled

When P0-22=1, the maximum value of the Max. frequency (P0-10) is 3200.0Hz;

- a) P0-16 is automatically set to 0 (carrier frequency is not adjusted);
- b) If the Max. frequency (P0-10) is less than 320.00Hz, The Max. frequency (P0-10), Frequency reference upper limit (P0-12) and Rated motor frequency (P1-04) of the motor will be 10 times the original. For example, when P0-10=P0-12=P1-04=50.00Hz in factory, After this operation all become 500.0Hz;
- c) Please set the carrier frequency (P0-15) above 8.0kHz;

2: Disabled

Set the digital frequency set value of P0-08 with the control panel and then modify it by UP/DOWN key. After stopping the machine, the frequency modification value is saved.

When P0-22=2, the maximum value of the Max. frequency (P0-10) is 500.00Hz;

- a) P0-16 is automatically set to 0 (carrier frequency is automatically adjusted with temperature);
- d) The Max. frequency (P0-10), Frequency reference upper limit (P0-12) and Rated motor frequency (P1-04) become 1/10 of the original;

Note:

- a) If P0-01 is not 2 (V/F control), P0-22 can only be set to 2;
- b) When modifying P0-22 parameters, please be sure to check the following parameters: the Max. frequency (P0-10), Frequency reference upper limit (P0-12), Rated motor frequency (P1-04), Torque boost (P3-01) and Cut-off frequency of torque boost (P3-02), otherwise the expected operation condition cannot be achieved.

P0-23	Retentive of digital setting frequency upon stop	
	0 to 1	0

0: Not retentive

The inverter resumes frequency reference to the value set in P0-08 at stop. Frequency reference continues from the value of P0-08 at next power-on.

1: Retentive

The inverter retains the frequency reference that was last reached at stop. Frequency reference continues from the retained value at next power-on.

P0-24	Motor parameter group selection	
	0 to 1	0

0: Motor parameter group 1

1: Motor parameter group 2

P0-25	Acceleration/ Deceleration time base frequency	
	0 to 2	0

0: Maximum frequency (P0-10)

1: Frequency reference

2: 100 Hz

P0-26	Base frequency for UP/DOWN modification during running	
	0 to 1	0

0: Running frequency

1: Frequency reference

P0-27	Running command + frequency source	
	0 to 999	0

Hundreds	Tens	Ones
----------	------	------

operating panel (keypad & display) + frequency reference setting channel
 0: No function
 1: Digital setting
 2: AI1
 3: AI2
 4: Panel potentiometer setting
 5: Pulse reference (X6)
 6: Multi-reference
 7: Simple PLC
 8: PID reference
 9: Serial communication

terminal I/O control + frequency reference setting channel, ditto.

serial communication + frequency reference setting channel, ditto.

P1 Group - Motor 1 Parameters

P1-00	Motor type selection	
	0 to 1	0

0: Common asynchronous motor

1: Variable frequency asynchronous motor

P1-01	Rated motor power	
	0.1kW to 1000.0kW	Depending on model
P1-02	Rated motor voltage	
	1V to 2000V	Depending on model
P1-03	Rated motor current	
	0.01A to 6553.5A	Depending on model
P1-04	Rated motor frequency	
	0.01 Hz to max. frequency	Depending on model
P1-05	Rated motor speed	
	1rpm to 65535rpm	Depending on model

Notice:

These above function codes must be set according to motor nameplate parameter. And please deploy the corresponding motor according the VFD power, or the control performance of VFD will decrease if the motor power differs too much from VFD power.

In order to ensure the control performance, the power level of the motor and the inverter should be matched. Generally, only one level larger or smaller than the inverter is allowed.

P1-06	Stator resistance	
	0.0001Ω to 65.535Ω	Auto-tuning parameter
P1-07	Rotor resistance	
	0.0001Ω to 65.535Ω	Auto-tuning parameter
P1-08	Leakage inductive reactance	
	0.001mH to 655.35mH	Auto-tuning parameter
P1-09	Mutual inductive reactance	
	0.01mH to 6553.5mH	Auto-tuning parameter
P1-10	No-load current	
	0.01A to P1-03	Auto-tuning parameter

The defaults of P1-06 to P1-10 are the preset values of the motor matched by the inverter according to its power. If you know the preceding parameters, you can enter them directly. After the motor is automatically tuned, the values of P1-06 to P1-10 will be updated automatically.

P1-27	Encoder pulses per revolution	
	1 to 65535	1024

In FVC mode, P1-27 must be set correctly. Otherwise, motor cannot run properly.

P1-30	A/B phase sequence of ABZ incremental	
	0: Forward 1: Reverse	0

0: Phase A is advanced of phase B for forward motor rotation. Phase B is advanced of phase A for reverse motor rotation.

1: Phase B is advanced of phase A for forward motor rotation. Phase A is advanced of phase B for reverse motor rotation.

P1-36	Encoder wire-break fault detection time	
	0.0s: No detection 0.1s to 10.0s	0.0s

If P1-36 is set to 0.0s, detection is disabled. If wire-break detection time exceeds the value set in P1-36, the inverter will trip with F20.

P1-37	Auto-tuning selection	
	0 to 3	0

0: Motor auto-tuning is not performed

1: Static auto-tuning 1

Step 1: Power on the inverter. Set P0-02 = 0 to select the operation panel as command source.

Step 2: Input motor nameplate parameters (P1-00 to P1-05) correctly.

Step 3: Set P1-37 = 1 to select static auto-tuning 1. Press on the operation panel. The operation panel displays "TUNE";

Step 4: Press on the operation panel.

Motor does not rotate but gets energized. The RUN indicator becomes ON.

After the preceding display disappears and the operation panel returns to normal parameter display state, it indicates that auto-tuning is completed.

Parameters P1-06 to P1-08 are obtained.

2: Dynamic auto-tuning

Step 1: Power on the inverter. Set P0-02 = 0 to select the operation panel as command source.

Step 2: Input motor nameplate parameters (P1-00 to P1-05) correctly.

Step 3: Set P1-37 = 2 to select dynamic auto-tuning. Press ENTER on the operation panel. The operation panel displays

Step 4: Press RUN on the operation panel.

The inverter drives motor to accelerate/decelerate and run in forward/reverse direction. The RUN indicator becomes ON and auto-tuning lasts for a period.

After the preceding display disappears and the operation panel returns to normal parameter display state, it indicates that auto-tuning is completed.

Parameters P1-06 to P1-10 and P1-30 are obtained.

3: Static auto-tuning 2

Step 1: Power on the inverter. Set P0-02 = 0 to select operating panel as command source.

Step 2: Input motor nameplate parameters (P1-00 to P1-05) correctly.

Step 3: Set P1-37 = 3 to select the static auto-tuning 2. Press ENTER on the operation panel. The operation panel displays

Step 4: Press RUN on the operation panel.

Motor does not rotate but gets energized. The RUN indicator becomes ON.

After the preceding display disappears and the operation panel returns to normal parameter display state, it indicates that auto-tuning is completed.

Parameters P1-06 to P1-10 are obtained.

Note: In addition to the above three methods, users can also manually input motor parameters.

P2 Group - Vector Control Parameters of Motor 1

P2-00	Speed loop proportional gain 1	
	1 to 100	30
P2-01	Speed loop integral time 1	
	0.01s to 10.00s	0.50s
P2-02	Switchover frequency 1	
	0.00 to P2-05 (Switchover frequency 2)	5.00 Hz
P2-03	Speed loop proportional gain 2	
	1 to 100	20
P2-04	Speed loop integral time 2	
	0.01s to 10.00s	1.00s
P2-05	Switchover frequency 2	
	P2-02 (Switchover frequency 1) to maximum frequency	10.00 Hz

Speed loop PI parameters are divided into high and low speed groups. When the operating frequency is less than "Switchover frequency 1" (P2-02), speed loop PI adjustment parameters are P2-00 and P2-01. When the operating frequency is greater than Switchover frequency 2, the speed loop PI adjustment parameters are P2-03 and P2-04. PI parameters between Switchover frequency 1 and Switchover frequency 2 are linear conversion of PI parameters of high and low groups, as shown in the figure below:

Through P2-00 to P2-05, the proportional gain P and integral time constant I of the speed regulator (ASR) can be set to change the speed response characteristics of the vector control.

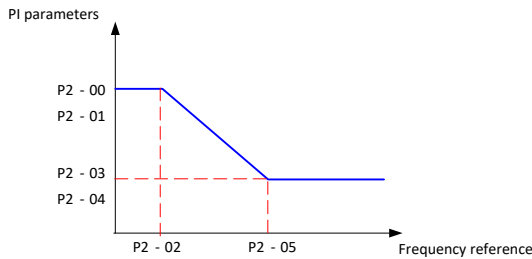

Figure 6-3 Schematic diagram of speed loop regulator parameter switching

a. Constitution of speed regulator (ASR)

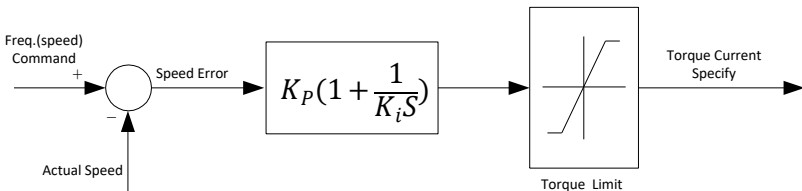

Figure 6-4 Speed regulator block diagram

In the figure, K_p is proportional gain P and K_i is integral time I.

When the integration time constant is set to 0 (P2-01=0, P2-04=0), there is no integration effect and the velocity loop is a simple proportional regulator.

b. Setting of proportional gain P and integral time constant I of the speed regulator (ASR) :

Increasing the proportional gain P can accelerate the dynamic response of the system. However, if P is too large, the system is prone to oscillations. The dynamic response of the system can be accelerated by decreasing the integral time I. But if I is too small, the system is prone to oscillations.

Usually, the proportional gain P is adjusted first, and P is increased as much as possible on the premise that the system does not oscillate. Then adjust the integration time to make the system have fast response characteristics and small overshoot. Figure 6-5 is the velocity step response curve when P and I are well selected.

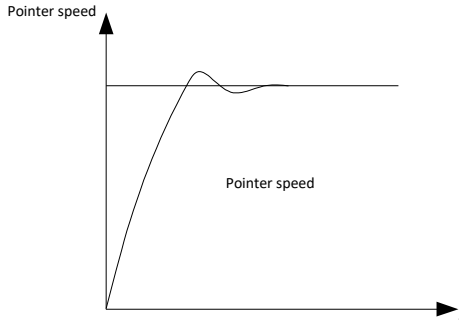

Figure 6-5 Step response curve with good dynamic performance

Note: speed loop PI parameters selection is not at the time, system to the callback after the rapid acceleration, deceleration overvoltage faults may be produced (if there is no external braking resistor or braking units), this is because in the process of reduction of speed overshoot, the state of regenerative braking energy feedback system, can be avoided by adjusting the parameters of PI.

P2-06	Vector control slip compensation gain	
	50% to 200%	100%

In vector control mode (P0-01=0 or 1), these above function codes are used to adjust steady-speed precision of motor. When motor is overload and the speed is low, increase the parameter, otherwise decrease the parameter.

In speed sensor vector control mode(P0-01=1), this parameter can adjust the output current size under the same load, such as in the high power inverter, if the carrying capacity is weak, can be gradually reduced this parameter. Note: In general, you do not need to adjust this parameter.

P2-07	Speed feedback filter time in SVC	
	0.000s to 0.100s	0.015s

In vector control mode, the filter time of feedback speed is used for speed closed-loop. Increasing this value can improve the stability of the system, but the dynamic response speed is slow; otherwise, the response speed is fast. It should be noted that if this value is too small, the motor will oscillate.

P2-09	Torque limit source in speed control	
	0: P2-10 1: AI1 2: AI2 3: Panel potentiometer setting 4: Pulse reference (X6) 5: Serial comms. 6: Min. (AI1, AI2) 7: Max. (AI1, AI2) The full scale of 1-7 corresponds to P2-10.	0
P2-10	Digital setting of torque limit in speed control	
	0.0% to 200.0%	150.0%
P2-11	Torque limit source in speed control (regenerative)	
	0: P2-10 (electrical or regenerative) 1: AI 2: AI2	0

	3: Panel potentiometer setting 4: Pulse reference 5: Communication reference 6: Min. (AI1, AI2) 7: Max. (AI1, AI2) 8: P2-12 The full scale of 1-7 corresponds to P2-12.	
P2-12	Digital setting of torque limit in speed control (regenerative)	
	0.0% to 200.0%	150.0%

In speed control mode, the torque upper limit source can be set in 8 ways. In the electric state, the torque upper limit source is determined by P2-09; in the power generation state, the torque upper limit source is determined by P2-11. In the speed control mode, if P2-11 is set to 1-8, the upper limit of torque is distinguished between electric state and power generation state. The upper full range of torque in electric state is set by P2-10, and the upper full range of torque in power state is set by P2-12, as shown below:

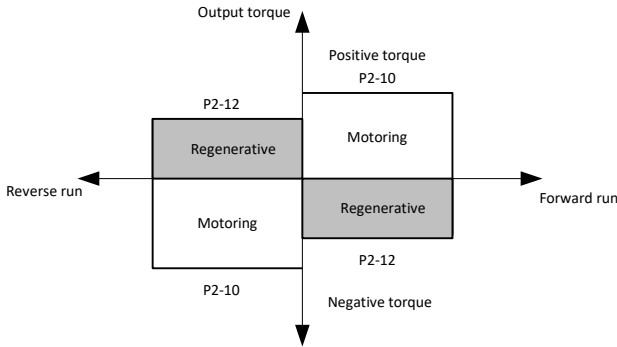

Figure 6-6 Schematic diagram of speed control mode torque upper limit

P2-13	Excitation adjustment proportional gain	
	0 to 60000	2000
P2-14	Excitation adjustment integral gain	
	0 to 60000	1300
P2-15	Torque adjustment proportional gain	
	0 to 60000	2000
P2-16	Torque adjustment integral gain	
	0 to 60000	1300

These function parameters (P2-13 to P2-16) are vector control current loop PI parameters. They are obtained from motor auto-tuning. Adjustment of these parameter is not required normally.

P2-17	Speed loop integral separation selection	
	0 to 1	0

0: Disabled

1: Enabled

When this parameter is set to 1, the overshoot of the speed loop can be reduced. Adjustment of the parameter is not required normally.

P2-21	Max. torque coefficient of field weakening area	
	50 to 200%	100%

This parameter takes effect only when the motor runs above the rated motor frequency.

When the motor need rapidly accelerate to twice of rated motor frequency but actual acceleration time is very long, decrease the setting of P2-21 adequately.

When the motor runs above twice of rated motor frequency and speed dip is very large after a load is added, increase the setting of P2-21 adequately. Adjustment of this parameter is not required normally.

P2-22	Regenerative power limit selection	
	0 to 1	0

0: Disabled

1: Enabled

P2-23	Regenerative power limit	
	0.0 to 200.0%	Model dependent

In applications such as cam, quick acceleration/deceleration and sudden unloading without using braking resistor, reduce bus voltage overshoot during motor braking so as to prevent occurrence of overvoltage.

P2-23 is a percentage of rated motor power. If overvoltage still occurs after you set P2-22= 1 , decrease setting of P2-23.

P3 Group - V/F Control parameters

P3-00	V/F curve setting	
	0: Linear V/F 1: Multi-point V/F 2-9: Reserved 10: V/F complete separation mode 11: V/F half separation mode	0
P3-01	Torque boost	
	0.0% to 30.0%	Model dependent
P3-02	Cut-off frequency of torque boost	
	0.00 Hz to the maximum frequency	50.00 Hz
P3-03	Multi-point V/F frequency 1	
	0.00 Hz to P3-05 (Multi-point V/F frequency 2)	0.00 Hz
P3-04	Multi-point V/F voltage 1	
	0.0% to 100.0%	0.0%
P3-05	Multi-point V/F frequency 2	
	P3-03 (Multi-point V/F frequency 1) to P3-07 (Multi-point V/F frequency 3)	0.00 Hz
P3-06	Multi-point V/F voltage 2	
	0.0% to 100.0%	0.0%
P3-07	Multi-point V/F frequency 3	
	P3-05 (Multi-point V/F frequency 2) to P1-04 (Rated motor frequency)	0.00 Hz
P3-08	Multi-point V/F voltage 3	
	0.0% to 100.0%	0.0%
P3-10	V/F over-excitation gain	
	0 to 200	64

In V/F control mode, the value of this parameter can be increased to improve the braking effect of the inverter.

P3-11	V/F oscillation suppression gain	
	0 to 100	40

In V/F control mode, you can increase this parameter if current oscillation occurs.

V/F curve setting

1) Linear V/F

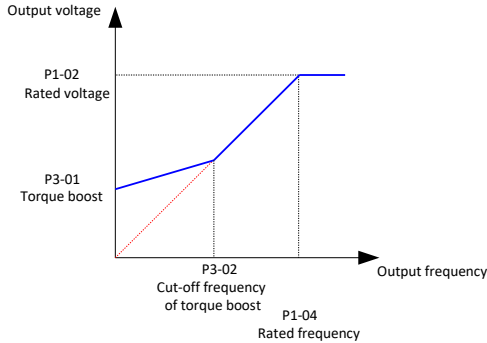

Figure 6-7 linear V/F curve

2) Multi-point V/F curve

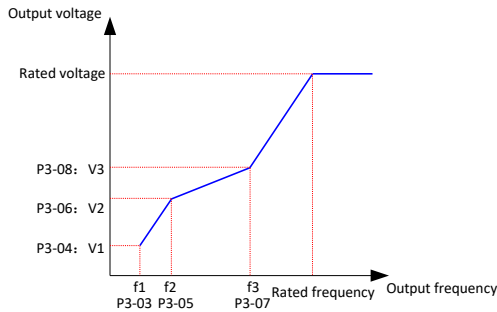

Figure 6-8 Multi-point V/F curve

P3-03 to P3-08 define the multi-point V/F curve. The range of frequency points is 0.00Hz to the rated frequency of the motor, and the range of voltage points is 0.0% to 100%, corresponding to 0V to the rated voltage of the motor. You must set multi-point V/F curve based on motor's load characteristic. The three voltage points and frequency points must satisfy: $V1 < V2 < V3$, $f1 < f2 < f3$. When you set F1 (P3-03), F2 (P3-05) and F3 (P3-07), set P3-07 first, then P3-05 and finally P3-03.

P3-13	Voltage source for V/F separation	
	0: Digital setting (Set by P3-14) 1: AI1 2: AI2 3: Panel potentiometer setting 4: Pulse reference (X6) 5: Multi-reference 6: Simple PLC 7: PID reference 8: Serial comms. Note: 100.0% corresponds to the rated motor voltage	0

0: Digital setting (Set by P3-14)

1 to 3: Determined by AI1, AI2 and Panel potentiometer, the input value is 100.0% corresponding to the rated voltage.
 4 to 8: PULSE setting (X6), multi-section instruction, simple PLC and communication setting.

Specify target voltage value by analog quantity AI2, and the corresponding physical quantity P4-29 of AI2 should be set as 2 (voltage directive).

When p3-13 is not 0, 1000 corresponds to 100.0% of the rated voltage of the motor, and when it exceeds 1000, the rated voltmeter is used.

Note: in V/F semi-separation mode, the output voltage is 2 times of the set value. If it exceeds the rated voltage, it shall be calculated according to the rated voltage.

P3-14	Digital setting of voltage for V/F separation	
	0 V to rated motor voltage	0 V

V/F complete separation mode: output voltage is equal to the set value;

V/F semi-separation mode: the output voltage is 2 times of the set value, if the output voltage exceeds the rated voltage, it is calculated according to the rated voltage;

P3-15	Voltage rise time of V/ F separation	
	0.0s to 1000.0s	0.0s

V/F complete separation mode: indicates the time when the voltage increases from 0V to the rated voltage of the motor

P3-16	Voltage decline time of V/F separation	
	0.0s to 1000.0s	0.0s

V/F complete separation mode: indicates the time required by the motor rated voltage to drop to 0V.

P3-17	Stop mode selection for V/F separation	
	0 to 1	0

0: Frequency and voltage declining to 0 dependently

1: Frequency declining after voltage declines to 0

P3-18	Current limit level	
	50% to 200%	150%

P3-19	Current limit selection	
	0: Disabled 1: Enabled	1(Enabled)

P3-20	Current limit gain	
	0 to 100	20

In V/F mode, if P3-19 is 1, overloss rate will take effect when the output current exceeds P3-18. At this point, the output frequency will decrease until the current drops below the loss rate point, and the frequency begins to accelerate to the target frequency, that is, the actual acceleration time becomes longer.

P3-21	Compensation factor of speed multiplying current limit	
	50% to 200%	50%

In high frequency area, motor drive current is small. Bigger motor speed dip is caused by current limit level compared with below rated frequency. To improve motor running characteristic, you can lower current limit level above rated frequency. When the value is 50%, the compensation coefficient is invalid.

P3-22	Voltage limit	
	650.0 V to 800.0 V	720.0 V

This parameter is used to limit the error amplitude of voltage regulation in close-loop mode, so as to keep the voltage in the safe range and the equipment working reliably.

Three-phase 380 to 480V: 650.0 V to 800.0 V, Default: 720.0 V;

One-phase 200 to 240V: 330.0 V to 420.0 V, Default: 380.0 V.

P3-23	Voltage limit selection	
	0 to 1	1

0: Disabled

1: Enabled

P3-24	Frequency gain for voltage limit	
	0 to 100	30

Increasing P3-24 can improve the control effect of bus voltage, but the output frequency will fluctuate. If the output frequency fluctuates greatly, p3-24 can be appropriately reduced.

P3-25	Voltage gain for voltage limit	
	0 to 100	30

Increasing P3-25 can reduce the overshoot of bus voltage.

P3-26	Frequency rise threshold during voltage limit	
	0 to 50 Hz	5 Hz

P3-26 is the limit value of the maximum rising frequency during overvoltage suppression adjustment.

P4 Group - Digital Input Parameters

P4-00	Input terminal X1 function selection	
	0 to 52	1
P4-01	Input terminal X2 function selection	
	0 to 52	2
P4-02	Input terminal X3 function selection	
	0 to 52	9
P4-03	Input terminal X4 function selection	
	0 to 52	12
P4-04	Input terminal X5 function selection	
	0 to 52	13
P4-05	Input terminal X6 function selection	
	0 to 52	8

Parameters P4-00 to P4-05 define the functions of input terminals X1 to X6.

0: No function

When the control terminal is idle, you can set the function of the unused terminal to 0 to prevent misoperation.

1: Forward RUN (FWD) or running command

In two-wire control mode 1 (P4-11=0), it is forward operation; two-wire control mode 1 (P4-11=1) is run command.

2: Reverse RUN (REV) or running direction

Three-wire control mode 1 (P4-11=2) is reverse operation; three-wire control mode 2 (P4-11=3) is run command.

3: Three-wire control

When selecting three-wire control mode (P4-11=2 or 3), as the control terminal of three-wire operation.

4: Forward JOG (FJOG)

The inverter is running in positive rotation point. For the running frequency, acceleration and deceleration time, see P8-00, P8-01, P8-02.

5: Reverse JOG (RJOG)

Invert and point operation of the inverter. For the running frequency, acceleration and deceleration time, please refer to P8-00, P8-01, P8-02.

6: Terminal UP

Increasing frequency terminal: when the terminal connection is valid, it is equivalent to pressing the UP key all the time; when the terminal is invalid, it is equivalent to releasing the UP key.

7: Terminal DOWN

Decreasing frequency terminal: when the terminal connection is valid, it is equivalent to pressing DOWN key all the time; when it is invalid, it is equivalent to releasing DOWN key.

8: Coast to stop

When the terminal connection is valid, the inverter stops output immediately and the motor stops freely. 9: Fault reset (RESET)

When the terminal connection is valid, the reset function is equivalent to the STOP/RST key on the keyboard.

10: RUN pause

The inverter slows down and stops. When the terminal connection is effective, all parameters are remembered (PLC parameters, PID parameters, etc.). After the terminal connection is invalid, restore all previous memory running state.

11: External fault normally open (NO) input

When the terminal connection is valid, the inverter reports F15 fault.

12 to 15: Multi-reference terminal 1 to 4

The four multi-reference terminals have 16 state combinations, corresponding to 16 references, as listed in the following table.

Stage	Terminal 4	Terminal 3	Terminal 2	Terminal 1	Corresponding Parameters
0	OFF	OFF	OFF	OFF	PC-00(PC-51=0)
1	OFF	OFF	OFF	ON	PC-01
2	OFF	OFF	ON	OFF	PC-02
3	OFF	OFF	ON	ON	PC-03
4	OFF	ON	OFF	OFF	PC-04
5	OFF	ON	OFF	ON	PC-05
6	OFF	ON	ON	OFF	PC-06
7	OFF	ON	ON	ON	PC-07
8	ON	OFF	OFF	OFF	PC-08
9	ON	OFF	OFF	ON	PC-09
10	ON	OFF	ON	OFF	PC-10
11	ON	OFF	ON	ON	PC-11
12	ON	ON	OFF	OFF	PC-12
13	ON	ON	OFF	ON	PC-13
14	ON	ON	ON	OFF	PC-14
15	ON	ON	ON	ON	PC-15

Note: The control terminal is connected to "1" (ON), disconnected to "0" (OFF)

16 to 17: Terminal 1, 2 for acceleration/deceleration time selection

Two terminals for acceleration/deceleration time selection have four state combinations. For details, see P0-17, P0-18, P8-03 to P8-08.

18: Frequency source switchover

According to the set value of P0-07 (Final Frequency reference setting selection), the two frequency instructions can be switched.

19: UP and DOWN setting clear (terminal, operating panel)

When setting the main frequency on the panel, you can select this function to clear the frequency value changed by the UP/DOWN key or the UP/DOWN terminal on the panel and restore the set frequency to the value set by P0-08.

20: Running command switchover terminal 1

21: Acceleration/ Deceleration prohibited

The inverter keeps the current output frequency unchanged except for the stop command.

22: PID pause

The inverter keeps the current output frequency unchanged except for the stop command.

23: PLC status reset

The inverter is restored to its original state under simple PLC control.

24: Swing pause

In swing frequency control mode, the swing frequency function is suspended when the terminal is connected.

25: Counter input

When the terminal connection is valid, it is input as a counting pulse.

26: Counter reset

When the terminal connection is valid, the count pulse value is cleared.

27: Length count input

When the terminal connection is valid, it is used as input for length count.

28: Length reset

When the terminal connection is valid, the length meter value is cleared.

29: Torque control prohibited

In torque control mode, if the terminal connection is valid, the torque control mode is switched to speed control mode. Return to torque control mode when terminal connection is invalid.

30: Pulse input (enabled only for X6)

If this function is selected for the X6 input terminal and P0-03 or P0-04 is set to 5, X6 is used as the pulse input terminal.

31: Reserved

32: Immediate DC injection braking

When the terminal connection is valid, the inverter switches immediately to DC injection braking.

33: External fault normally closed (NC) input

When the terminal connection is valid, the inverter reports F15 fault.

34: Frequency modification enabled

The terminal connection is valid, allowing the frequency to be modified; The terminal connection is invalid, then do not modify the frequency.

35: PID action direction reverse

The direction of PID is opposite to that set by PA-03.

36: External STOP terminal 1

When " Running command selection " is set to the operation panel (P0-02=0), the inverter will stop, which is equivalent to the stop key on the panel.

37: Running command switchover terminal 2

Terminal control and communication control running command switch. Under terminal control running instruction, switch to communication control when terminal connection is effective; Under communication control operation instruction, switch to terminal control operation instruction when terminal connection is effective.

38: PID integral disabled

The integral function of PID is suspended, but the proportional adjustment and differential function of PID are still in effect.

39: Switchover between main frequency source and preset frequency

When the terminal is active, the main frequency is switched to preset frequency (P0-08).

40: Switchover between auxiliary frequency source and preset frequency

When the terminal is active, the auxiliary frequency is switched to the preset frequency (P0-08).

41: Motor terminal selection

Select motor parameter group 1 or 2; Select set 1 if the terminal connection is invalid and set 2 if the terminal connection is valid.

42: Reserved

43: PID parameter switchover

If PA-18 is 1 and the terminal connection is invalid, the PID parameter ranges from PA-05 to PA-07. If the terminal connection is valid, select PA-15 to PA - 17.

44: User-defined fault 1

The Inverter alarm F27, it will process according to the set value of P9-49 (Fault protection action selection).

45: User-defined fault 2

The Inverter alarm F28, it will process according to the set value of P9-49 (Fault protection action selection).

46: Speed control/ Torque control switchover

The inverter switches between torque control and speed control modes.

When d0-00 is 0 and the terminal connection is valid, the control mode is torque mode. If the terminal connection is invalid, the control mode is speed mode.

When d0-00 is 1 and the terminal connection is valid, the control mode is speed mode. When the terminal connection is invalid, the control mode is torque mode.

47: Emergency stop

Stop the machine in emergency state. In V/F mode, when the emergency stop deceleration time is 0s, the machine decelerates according to the minimum time unit. There is no need for the terminal to be valid continuously, the terminal only needs to be valid once to trigger a quick stop. It should be noted that the inverter will not start when the terminal connection is invalid and the running signal of the inverter is still valid after the quick stop. The user needs to disconnect the terminal and input the running instruction of the terminal again before the inverter restarts.

48: External STOP terminal 2

As long as the terminal connection is valid, the inverter will slow down and stop. At this time, the deceleration time is determined by parameter P8-08.

49: Deceleration DC injection braking

The Inverter first decelerate, reach direct braking initial frequency (P6-11), enter stage of DC injection braking.

50: Clear the current running time

If the current running time is less than the set value of P8-53 (Running time threshold this time) (greater than 0), the terminal connection is valid during this process, and the current run time is cleared. If the running time is greater than the set value of P8-53 (greater than 0), the terminal connection is valid, and the running time is not cleared.

51: Two-wire/Three-wire mode switchover

Used to switch between two-wire and three-wire control modes:

If P4-11=0 (two-wire control mode 1), switch to three-wire control mode 1 when the terminal connection is valid. If P4-11= 1 (two-wire control mode 2), switch to three-wire control mode 2 when the terminal connection is valid. If P4-11 is 2 (three-wire control mode 1), switch to two-wire control mode 1 when the terminal connection is valid. If P4-11 is 3 (three-wire control mode 2), switch to two-wire control mode 2 when the terminal connection is valid.

52: Reverse frequency forbidden

When the terminal connection is valid, if the set frequency is reverse, the actual set frequency of the inverter is limited to 0, which has the same function as reverse frequency disable (P8-13).

53-59: Reserved

P4-10	Input terminal X1 to X6 filter time	
	0.000s to 1.000s	0.010s

This function is used to set sensitivity of input terminal. If digital input terminal is susceptible to interference so as to cause error action, increase this parameter to improve the anti-interference ability, but overlarge value will result in a lower sensitivity.

P4-11	Terminal I/O control mode	
	0 to 4	0

For convenience, X1, X2 and X3 of X1 to X6 are arbitrarily selected as external control terminals, and their functions are set by parameters P4-00 to P4-02. For detailed function definitions, see P4-00 to P4-05.

0: Two-wire control mode 1

In two-wire control mode 1, the forward and reverse of the motor are controlled by X1 and X2 terminals, and the parameters are set as follows:

Parameters. Num	Parameter. Na	Value	Function Description
P4-11	Terminal I/O control mode	0	Two-wire control mode 1
P4-00	X1 function selection	1	Forward RUN (FWD)
P4-01	X2 function selection	2	Reverse RUN (REV)

K1	K2	Running Command
0	0	Forward
1	0	Reverse
0	1	Stop
1	1	Stop

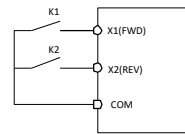

Figure 6-9 Two-wire control mode 1

As the figure above shows, when K1 is closed, motor rotates in forward direction; when K1 is open, motor stops. when K2 is closed, motor rotates in reverse direction. when K2 is open, motor stops; when K1 and K2 are both open or closed simultaneously, motor stops.

1: Two-wire control mode 2

In two-wire control mode 2, X1 is the running terminal, and X2 terminal determines the forward and reverse running directions. Parameter Settings are as follows:

Parameters. Num	Parameter. Na	Value	Function Description
P4-11	Terminal I/O control mode	1	Two-wire control mode 2
P4-00	X1 function selection	1	Forward RUN (FWD)
P4-01	X2 function selection	2	Reverse RUN (REV)

K1	K2	Running Command
0	0	Forward
1	0	Reverse
0	1	Stop
1	1	Stop

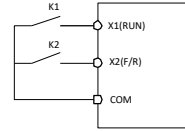

Figure 6-10 Two-wire control mode 2

As the figure above shows, when K1 is closed, motor rotates in forward direction with K2 open; when K1 is closed, motor rotates in reverse direction with K2 closed; when K1 is open, motor stops no matter whether K2 is open or closed.

2: Three-wire control mode 1

In Three-wire control mode 1, X3 is a three-wire operating terminal, and the running direction is determined by X1 and X2. Parameter Settings are as follows:

Parameters. Num	Parameter. Na	Value	Function Description
P4-11	Terminal I/O control mode	2	Three-wire control mode 1
P4-00	X1 function selection	1	Forward RUN (FWD)
P4-01	X2 function selection	2	Reverse RUN (REV)
P4-02	X3 function selection	3	Three wire control

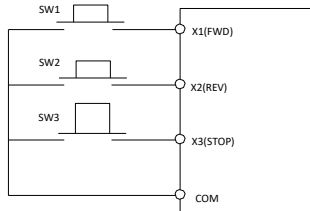

Figure 6-11 Three-wire control mode 1

As shown in the figure, when the button SW3 is closed, the inverter will turn forward when SW1 is pressed, inverts when SW2 is pressed, and stops when SW3 is disconnected. SW3 must be kept closed during normal startup and operation. The commands of buttons SW1 and SW2 take effect immediately along the closing action, and the running state of the inverter is subject to the last key action of the three buttons.

3: Three-wire control mode 2

In Three-wire control mode 1, X3 is a three-wire operating terminal, the running command is determined by X1, and the running direction is determined by X2. Parameter Settings are as follows:

Parameters. Num	Parameter. Na	Value	Function Description
P4-11	Terminal I/O control mode	3	Three-wire control mode 2
P4-00	X1 function selection	1	Forward RUN (FWD)
P4-01	X2 function selection	2	Reverse RUN (REV)
P4-02	X3 function selection	3	Three wire control

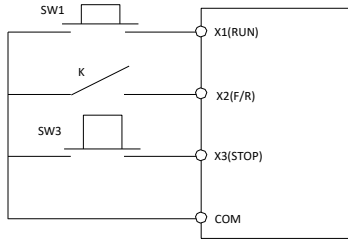

Figure 6-12 Three-wire control mode 2

As shown in the figure, under the closed state of SW3, press the SW1 button to run the inverter; when K is off, the inverter turns forward, when K is closed, the inverter reverses; SW3 is disconnected and the inverter stops instantly. During normal startup and operation, SW3 must be kept in the closed state, and the command of SW1 takes effect immediately along the closed action.

4: Pulse button control start and stop

By setting the following parameters, the pulse-type button can control the start and stop of motor.

- 1) Set P0-02 to 1 (In Terminal control);
- 2) P4-11 set to 4 (pulse button start/stop);
- 3) P4-00 set to 1 (Forward RUN);
- 4) P4-01 set to 2 (Reverse RUN);

At stop, press the pulse button corresponding to X1, and motor rotates in forward direction; When pressed again, motor stops. At stop, Press the pulse button corresponding to X2, and motor rotates in reverse direction; When pressed again, motor stops.

P4-12	Terminal UP/DOWN rate	
	0.001Hz/s to 65.535Hz/s	1.00Hz/s

This function is defined as: Set the frequency change rate when the terminal UP/DOWN setting frequency is used.

P4-13	AI curve 1 min. input	
	0.00 V to P4-15 (AI curve 1 max. input)	0.00 V
P4-14	Corresponding percentage of AI curve 1 min. input	
	-100.0% to +100.0%	0.0%
P4-15	AI curve 1 max. input	
	P4-13 (AI curve 1 min. input) to 10.00 V	10.00 V
P4-16	Corresponding percentage of AI curve 1 max. input	
	-100.0% to +100.0%	100.0%
P4-17	AI1 filter time	
	0.00s to 10.00s	0.10s

Parameters P4-13 and P4-14 define the minimum input of AI curve 1 and its corresponding set value. P4-15 and P4-16 define the maximum input of AI curve 1 and its corresponding set value; P4-17 is the filtering time of the analog input AI1.

P4-18	AI curve 2 min. input	
	0.00 V to P4-20 (AI curve 2 max. input)	0.00 V
P4-19	Corresponding percentage of AI curve 2 max. input	
	-100.0% to +100.0%	0.0%
P4-20	AI curve 2 max. input	
	P4-18 (AI curve 2 min. input) to 10.00 V	10.00 V
P4-21	Corresponding percentage of AI curve 2 max. input	
	-100.0% to +100.0%	100.0%
P4-22	AI2 filter time	
	0.00s to 10.00s	0.10s

Parameters P4-18 to P4-22 define the characteristics of AI curve 2, which are described the same as AI curve 1.

P4-23	Panel potentiometer curve min. input	
	-10.00 V to P4-25 (AI curve 3 max. input)	-10.00 V
P4-24	Corresponding percentage of AI curve 3 min. input	
	-100.0% to +100.0%	-100.0%
P4-25	AI curve 3 max. input	
	P4-23 (Panel potentiometer curve min. input) to 10.00 V	10.00 V
P4-26	Corresponding percentage of AI curve 3 max. input	
	-100.0% to +100.0%	100.0%
P4-27	Panel potentiometer filter time	
	0.00s to 10.00s	0.50s

Parameters P4-23 to P4-27 define the characteristics of AI curve 3, which are described the same as AI curve 1.

P4-28	Pulse min. input	
	P4-23 (Panel potentiometer curve min. input) to 10.00 V	0.00 kHz
P4-29	Corresponding percentage of pulse min. input	
	-100.0% to 100.0%	0.0%
P4-30	Pulse max. input	
	P4-28 (Pulse min. input) to 100.00 kHz	50.00 kHz
P4-31	Corresponding percentage of pulse max. input	
	-100.0% to 100.0%	100.0%
P4-32	Pulse filter time	
	0.00s to 10.00s	0.10s

P4-28 to P4-32 are the input terminal X6 as the set parameters of the pulse input, and the corresponding relationship is a straight line defined by 2 points. 100.0% of the set value of the pulse input is the percentage relative to the maximum frequency P0-10.

P4-33	AI curve selection	
	111 to 555	121

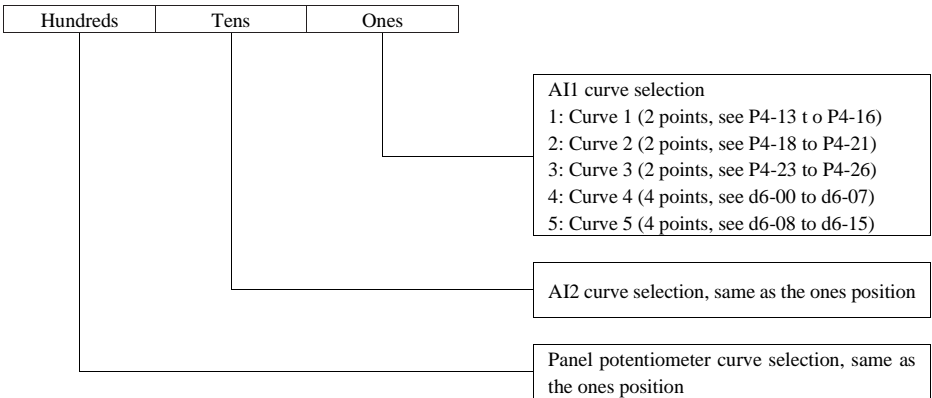

P4-34	Setting selection when AI less than min. input	
	000 to 111	000

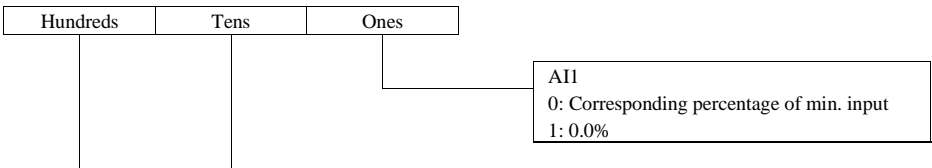

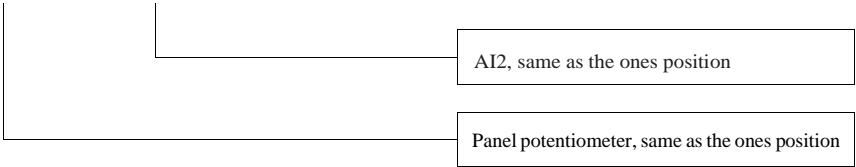

P4-35	X1 delay time	
	0.0s to 3600.0s	0.0s
P4-36	X2 delay time	
	0.0s to 3600.0s	0.0s
P4-37	X3 delay time	
	0.0s to 3600.0s	0.0s

When state of X terminals changes, these three function parameters set delay time of the change.

Note: Now the drive supports delay function on X1, X2 and X3 only.

P4-38	X1 to X5 active mode selection 1	
	00000 to 11111	00000

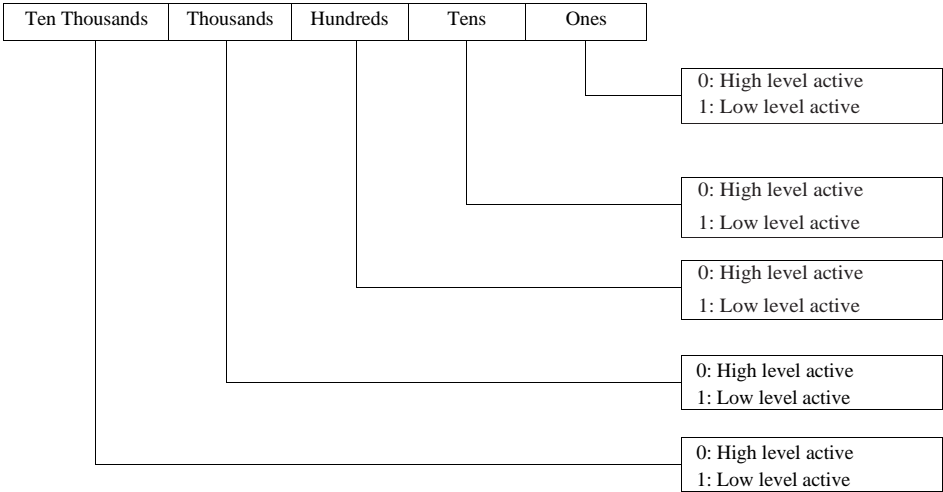

P4-39	X6 active mode selection 2	
	0 to 1	0

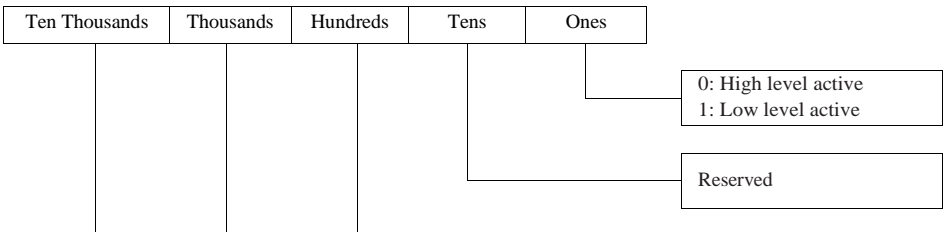

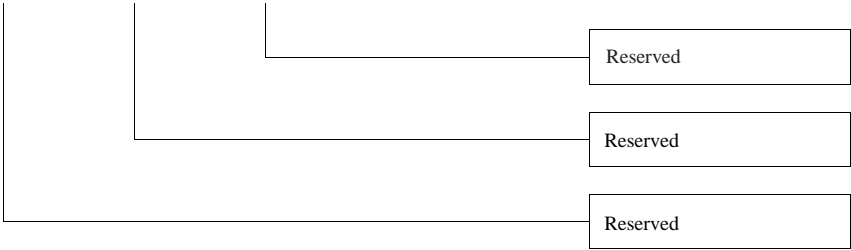

P4-40	All input mode selection	
	0: 0.00V to 10V input	0
	1: 0.00mA to 20 mA input	

When the value is set to 0, the voltage input is 0-10V. If it is set to 1, 0 to 20.00mA current is input.

P5 Group - Digital Output Parameters

P5-00	Y terminal output mode	
	0 to 1	1

0: Y terminal outputs pulses, the frequency of which represents the value of variable which is assigned by P5-06.

1: Y terminal outputs switch signal, the value of which represents the status of variable which is assigned by P5-01

P5-01	Y terminal FMR function selection (open collector output terminal)	
	0 to 41	1
P5-02	Relay 1 function selection	
	0 to 41	2
P5-03	Relay 2 function selection (Optional accessories)	
	0 to 41	0

0: No output

1: inverter running

The inverter is in the running state, the inverter has an output signal (frequency can be zero), at this time the output valid signal.

2: Fault output (coast to stop)

When the inverter stops, the output effective signal.

3: Frequency-level detection FDT1 output

Used to set the detection value of the output frequency and the hysteresis value of the output action release. The lag value is only effective in the process of deceleration, and the detection does not lag in the process of acceleration, as shown in the figure above.

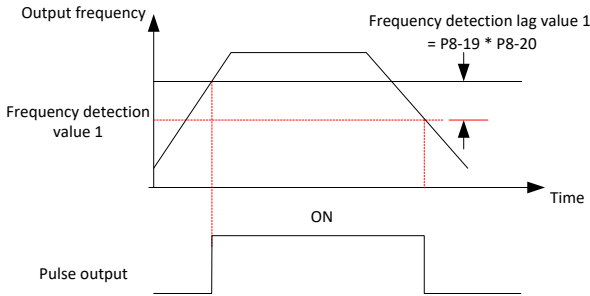

Figure 6-13 Schematic diagram of frequency level detection

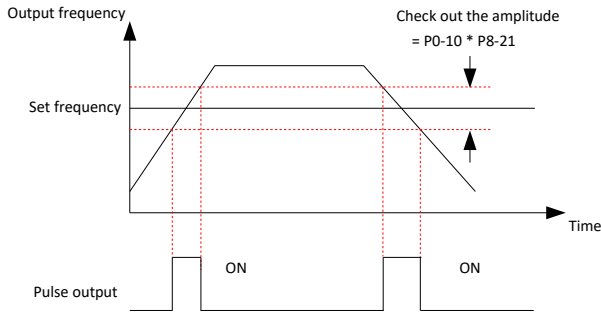

Figure 6-14 Time sequence diagram of frequency reaching detection amplitude

The output is valid when the operating frequency is between (target frequency - $P8-21 * P0-10$) and (target frequency + $P8-21 * P0-10$), otherwise the output is invalid.

5: Zero-speed running(no output at stop)

When the inverter is in operation and the output frequency is 0, the output is effective, and it is invalid in the shutdown state.

6: Motor overload pre-warning

Before the motor overload protection action, according to the overload warning coefficient ($P9-02$) judgment, output effective signal after exceeding the forecast alarm threshold.

7: Inverter overload pre-warning

Output effective signal 10 seconds before inverter overload protection.

8: Set count value reached

In the counting function, when the counting value reaches the set value of $Pb-08$, the effective signal will be output.

9: Designated count value reached

In the counting function, when the counting value reaches the set value of $Pb-09$, the effective signal will be output.

10: Length reached

In the function of fixed length, when the length gauge exceeds the set value of $Pb-05$, effective signal will be output.

11: PLC cycle completed

After completing a cycle in PLC, output a pulse signal of 250ms width.

12: Accumulative running time reached

When the accumulative running time exceeds the set value of $P8-17$ (set accumulative power-on arrival time), a valid signal is output.

13: Frequency limited

When the set frequency exceeds the upper limit frequency or is lower than the lower limit frequency, and the output frequency of the inverter reaches the upper limit frequency or the lower limit frequency, the effective signal will be output.

14: Torque limited

In speed control mode, when the output torque reaches the torque limit, the effective signal is output.

15: Ready for RUN

After the inverter is powered on, it will output effective signal when there is no abnormal state.

16: $A11 > A12$

Analog input $A11 > A12$, the effective signal is output.

17: Frequency upper limit reached

When the operating frequency reaches Frequency reference upper limit (P0-12), a valid signal is output.

18: Frequency lower limit reached (no output at stop)

When $P0-14=1$, no matter whether the operating frequency reaches the lower limit frequency, invalid signal is always output.

When $P0-14=0$ or 2 , and the operating frequency reaches the lower limit, the effective signal is output.

19: Undervoltage status output

When the inverter is under voltage, it outputs effective signal.

20: Communication setting

The output status is determined by the setting of address $0x2001$.

21: Reserved

22: Reserved

23: Zero-speed running 2 (having output at stop)

When the inverter runs and the output frequency is 0 , the effective signal is output. The inverter is also effective in the down state.

24: Accumulative power-on time reached

When the inverter runs and the output frequency is 0 , the effective signal is output. The inverter is also effective in the down state.

25: Frequency level detection FDT2 output When the operating frequency is greater than the frequency detection value $P8-28$, the output effective signal; When the operating frequency is lower than the frequency detection value minus the frequency detection lag value ($P8-28 * P8-29$), invalid signal is output.

26: Frequency 1 reached

When the operating frequency is within the frequency detection range of $P8-30$ (Detection of frequency 1), effective signal will be output.

Frequency detection range: $[P8-30-P8-31 * P0-10]$ to $[P8-30 + P8-31 * P0-10]$.

27: Frequency 2 reached

When the operating frequency is within the frequency detection range of $P8-32$ (Detection of frequency 2), effective signal will be output.

Frequency detection range: $[P8-32-P8-33 * P0-10]$ to $[P8-32 + P8-33 * P0-10]$.

28: Current 1 reached

The output current is in the range of $P8-38$ (Detection level of current 1), and the output effective signal.

Current detection range = $[P8-38-P8-39 * P1-03]$ to $[P8-38 + P8-39 * P1-03]$.

29: Current 2 reached

The output current is in the range of $P8-40$ (Detection level of current 2), and the output effective signal.

Current detection range = $[P8-40-P8-41 * P1-03]$ to $[P8-40 + P8-41 * P1-03]$.

30: Timing duration reached

If $P8-42=1$ (Enabled Timing function), when the running time reaches the set timing time, a valid signal is output.

31: A11 input limit exceeded

When the input value of analog quantity $A11$ is greater than $P8-46$ ($A11$ input voltage upper limit) or smaller than $P8-45$ ($A11$ input voltage lower limit), a valid signal is output.

32: Load lost

The Inverter in the state of load, output effective signal.

33: Reverse running

Inverter in reverse operation, output effective signal.

34: Zero current status

When the output current is in the zero current range and the duration exceeds $P8-35$ (Zero current detection delay), the output valid signal.

Zero current detection range = 0 to $P8-34 * P1-03$.

35: IGBT temperature reached

If the heat sink temperature of IGBT module (P7-07) exceeds the IGBT temperature threshold (P8-47), the inverter generates valid signals.

36: Software current limit exceeded

When the output current is greater than P8-36 (Output overcurrent threshold) and the duration exceeds P8-37 (Output overcurrent detection delay), a valid signal is generated.

37: Frequency lower limit reached (having output at stop)

When the operating frequency reaches the lower limit (P0-14), a valid signal is output.

Note: the shutdown state also outputs effective signals.

38: Alarm output

When the inverter fails and the protection action of the fault is selected as continuing operation, effective signal will be output. For details about fault protection actions, see P9-47 to P9-50.

39: Reserved

40: Current running time reached

When the start time of this run exceeds the time set by P8-53 (Running time threshold this time), a valid signal will be output.

41: Fault output (no output at undervoltage)

In case of inverter failure (except undervoltage failure), output effective signal.

P5-06	Y terminal FMP function selection	
	0-16	11
P5-07	AO1 function selection	
	0 to 16	0.0%

Frequency reference is input by means of X6 (high-speed pulse). Signal specification of pulse reference is 0 to 50 kHz (frequency range). The corresponding value 100% of pulse reference corresponds to the value of P0-10 (max. frequency). When P5-06=1 (frequency setting), if the frequency set by the inverter is 50% of the maximum frequency and P5-09 is 50kHz, then the output frequency of Y terminal is 50%*50kHz = 25kHz.

AO1 (analog output) 0 to 10V corresponds to 0% to 100%. When the output function of AO1 is 1 (frequency setting), if the frequency set by the inverter is 50% of the maximum frequency, the output voltage of AO1 is 50% * 10V = 5V.

Value	Output Function	Range
0	Running frequency	0 to max. frequency
1	Frequency reference	0 to max. frequency
2	Output current	0 to 2 times of rated motor current
3	Output torque (absolute value)	0 to 2 times of rated motor torque
4	Output power	0 to 2 times of rated power
5	Output voltage	0 to 1.2 times of rated inverter voltage
6	Pulse input	0.01 to 100.00 kHz
7	AI1	0 to 10 V
8	AI2	0 to 10 V (or 0 to 20 mA)
9	AI3	0 to 5 V
10	Length	0 to max. set length
11	Counting value	0 to max. count value
12	Communication reference	0.0% to 100.0%
13	Motor speed	0 to motor speed corresponding to max. output frequency
14	Output current	0.0 to 1000.0 A
15	Output voltage	0.0 to 1000.0 V
16	Output torque of the motor (actual value, a percentage of the rated motor torque)	-2 times of rated motor torque to 2 times of rated motor torque
17	Output torque of the inverter (actual value, a percentage of the rated inverter torque)	-

Note: Range: Corresponding to 0.0% to 100.0% of Pulse or Analog Output Range

P5-09	Y terminal Max. FMP output frequency	
	0.01kHz to 50.00kHz	50.00kHz

This function parameter sets maximum pulse output frequency when Y terminal is used for pulse output.

P5-10	AO1 zero offset coefficient	
	0.00 to 10.00V	10.00
P5-11	AO1 gain	
	-200.0% to 200.0%	0.0%

Setting method: It is assumed that the analog output value is the operating frequency. When the expected frequency is 0Hz (X1), the output will be 8V (Y1) after modification; when the frequency is 40Hz (X2), the output will be 4V (Y2) after modification.

Gain calculation formula:

Zero offset coefficient calculation formula:

Where Xmax is the maximum output frequency (assuming P0-10 is 50Hz) and Ymax is the maximum output frequency (voltage type is 10.00V and current type is 20.00mA), then Xmax=50Hz and Ymax=10.00V are substituted into the above equation, and p5-10 =80% and P5-11 can be obtained = 0.50.

P5-17	Y terminal FMR output delay time	
	0.00 to 10.00V	0.00
P5-18	Relay 1 output delay time	
	-200.0% to 200.0%	100.0%
P5-19	Relay 2 output delay time	
	0.00 to 10.00V	10.00

These parameters set output delay of terminals Y, relay1 and relay2 from state change.

P5-22	Active mode selection of Digital output terminals	
	-200.0% to 200.0%	0.0%

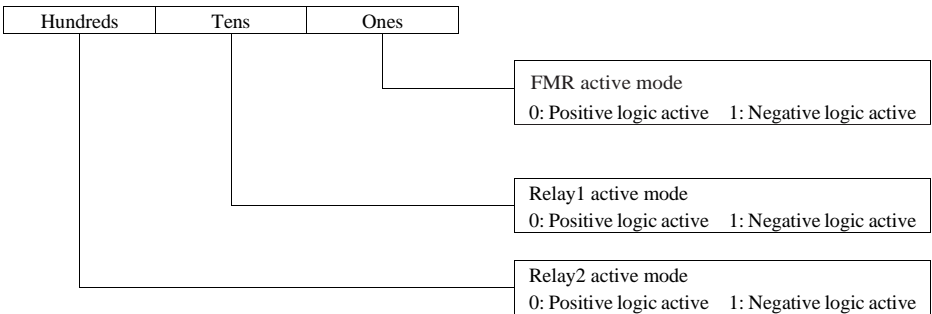

P6 Group - Start/Stop Control Parameters

P6-00	Start mode	
	0 to 3	0

0: Direct start

If the DC injection braking active time (P6-06=0) is 0, the inverter starts to run from the start frequency (P6-03); If the DC injection braking active time is not 0, the dc braking is carried out first, and then the operation starts from the start frequency, which is suitable for the load with small inertia.

1: Catching a spinning motor

For large inertia load, when the inverter starts, the load motor is still in the rotating state of application, using this starting mode can reduce the impact in the starting process. This startup mode is valid only in vector control mode (SVC or FVC).

2: Pre-excited start (AC asynchronous drive)

The induction motor is pre-excited before starting to improve the dynamic response speed to meet the needs of rapid acceleration applications. This startup mode is valid only in vector control mode.

3: SVC quick start

This startup mode is valid only in SVC control mode. This startup mode can be used in applications with large inertia and fast startup.

P6-01	Mode of catching a spinning motor	0
	0 to 2	
P6-02	Speed of catching a spinning motor	20
	1 to 100	

Parameter setting in Catching a spinning motor mode.

P6-03	Start frequency	0.00Hz
	0.00Hz to 10.00Hz	
P6-04	Start frequency holding time	0.0s
	0.0s to 100.0s	

In order to ensure the motor torque when starting, please set the start frequency (P6-03). In order to fully establish the magnetic flux when the motor starts, it is necessary to keep the starting frequency for a certain time.

The start frequency is not limited by the lower limit frequency, but when the set target frequency is less than the starting frequency, the inverter will not start and is in standby state. Start frequency hold time (P6-04) is not included in the acceleration time, but included in the running time of simple PLC.

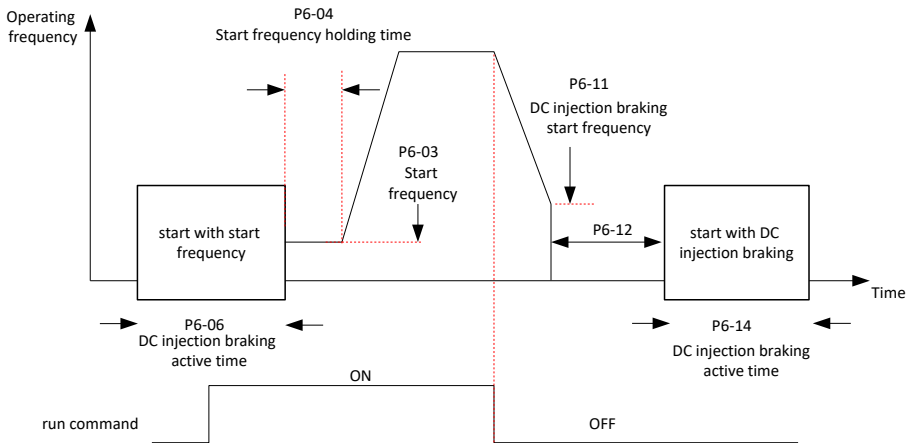

Figure 6-15 Time sequence diagram of frequency reaching detection amplitude

P6-05	DC injection braking level/Pre-excitation level	50%
	0% to 100%	
P6-06	DC injection braking active time/Pre-excitation active time	0.0s
	0.0s to 100.0s	

100% of P6-05 corresponds to the rated current of the motor. When this value is greater than 80% of the rated current of the inverter, it is automatically limited to 80% of the rated current of the inverter. Parameter P6-06 Duration of the starting braking process.

P6-07	Acceleration/Deceleration mode	
	0.0s to 100.0s	0.0s

This parameter defines how the frequency of the inverter changes during acceleration and deceleration:

0: Linear acceleration/deceleration

In the process of acceleration and deceleration, the output frequency and acceleration and deceleration time are linear, increasing or decreasing according to a constant slope, as shown in the figure below:

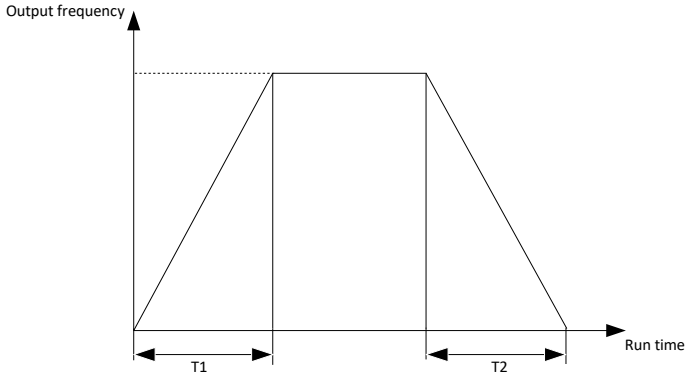

Figure 6-16 Schematic diagram of linear acceleration and deceleration

1-2: S-curve dynamic acceleration/deceleration

When the target frequency changes, the output frequency increases or decreases according to the S curve to achieve smooth acceleration and deceleration and impact mitigation. The frequency changes during acceleration and deceleration are shown in the figure below.

1) When P6-07=1, T1 is the initial period of acceleration, T3 is the end period of acceleration, T4 is the initial period of deceleration, T6 is the end period of deceleration, T2 and T5 are the linear acceleration time.

$$T1 = T4 = \text{Acceleration/deceleration time} * P6-08\%$$

$$T3 = T6 = \text{Acceleration/deceleration time} * P6-09\%$$

2) when P6-07=2, T1 is the initial period of acceleration, T3 is the end period of acceleration, T4 is the initial period of deceleration, T6 is the end period of deceleration, T2 and T5 are the linear acceleration time.

$$T1 = T6 = \text{Acceleration/deceleration time} * P6-08\%$$

$$T3 = T4 = \text{Acceleration/deceleration time} * P6-09\%$$

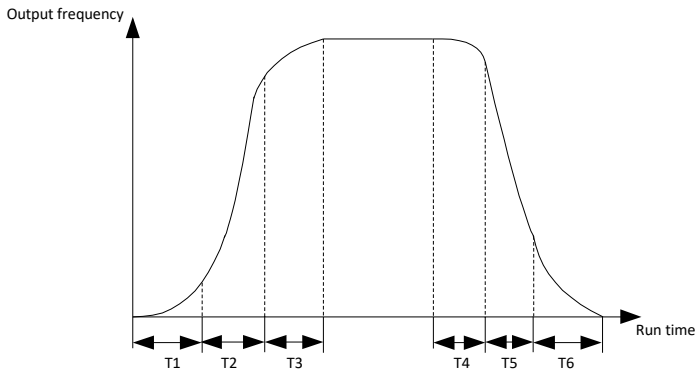

Figure 6-17 Schematic diagram of S-curve dynamic acceleration and deceleration

P6-08	Time proportion of S-curve start segment	
	0.0% to (100.0%-P6-09)	30.0%
P6-09	Time proportion of S-curve end segment	
	0.0% to (100.0%-P6-08)	30.0%

P6-08 and P6-09 define time proportion of start segment and end segment of S-curve acceleration/deceleration, respectively. They must satisfy $P6-08 + P6-09 \leq 100.0\%$.

P6-11	DC injection braking start frequency	
	0.00 Hz to the maximum frequency	0.00 Hz

The inverter starts DC injection braking when the running frequency decreases to the value set in this parameter in the process of deceleration to stop.

P6-12	DC injection braking delay time	
	0.0s to 100.0s	0.0s

When the running frequency decreases to the value set in P6-11, the inverter stops output for a period of time and then starts DC injection braking. This prevents the occurrence of fault such as overcurrent caused by direct DC injection braking at high speed.

P6-13	DC injection braking level	
	0% to 100%	50%

100% of P6-13 corresponds to the rated current of the motor. When this value is greater than 80% of the rated current of the inverter, it is automatically limited to 80% of the rated current of the inverter.

P6-14	DC injection braking	
	0.0s to 100.0s	0.0s

The duration of dc braking in shutdown. When stop brake time is 0.0s, there would be no DC brake process.

P6-15	Braking use ratio	
	0% to 100%	100%

The percentage of brake unit working time when the bus voltage exceeds braking unit applied voltage of P9-08.

P6-18	Catching a spinning motor current limit	
	30% to 200%(Motor rated current)	Model dependent

Set value of inverter current during speed tracking.

P6-21	Demagnetization time (effective for SVC)	
	0.00 to 5.00s	Model dependent

In SVC control mode, allow the motor current to attenuate the reserved time.

P7 Group - Parameters of Panel Function Setting and Parameter Management

P7-00	Reserved	
	0 to 4	0
P7-01	FUNC key function selection	
	0 to 5	3

0: FUNC key disabled

The key has no function

1: Switchover from remote control (terminal or communication) to operating panel control

P0-02 = 0, there is no effect after you press the FUNC key.

P0-02 = 1, command source can be switched over between terminal and operating panel through the FUNC key.

P0-02 = 2, command source can be switched over between communication and operating panel through the FUNC key.

2: Switchover between forward rotation and reverse rotation

Frequency reference direction can be switched over through the FUNC key. This function is valid only when command source is operating panel.

3: Forward jog

Forward jog of the drive can be implemented through the FUNC key. This function is valid only when command source is operating panel

4: Reverse jog

Forward jog of the drive can be implemented through the FUNC key. This function is valid only when command source is operating panel.

5: Reverse run

Reverse run of the drive can be implemented through the FUNC key. This function is valid only when command source is operating panel.

P7-02	STOP/RESET key function	
	0 to 1	1

0: STOP/RESET key enabled only in operating panel control

1: STOP/RESET key enabled in any operation mode

P7-03	LED display running parameters 1	
	0000 to FFFF	1F
P7-04	LED display running parameters 2	
	0000 to FFFF	0
P7-05	LED display stop parameters	
	0000 to FFFF	33

Parameters P7-03 to P7-05 define the run and stop status. For details about the parameters, see operation description on the panel.

P7-06	Load speed display coefficient	
	0.001 to 65.000	1.000

Used to display the proportional coefficient of load speed.

P7-07	Heatsink temperature of IGBT	
	-30°C to 120°C	-

Display the heatsink temperature of IGBT, read only.

P7-08	Rectifier bridge temperature	
	-30°C to 120°C	-

Displays the current temperature of the rectifier bridge, read only.

P7-09	Accumulative running time	
	0h to 65535h	-

Display the accumulative running time of the inverter, read only.

P7-12	Number of decimal places for load speed display	
	10 to 23	21

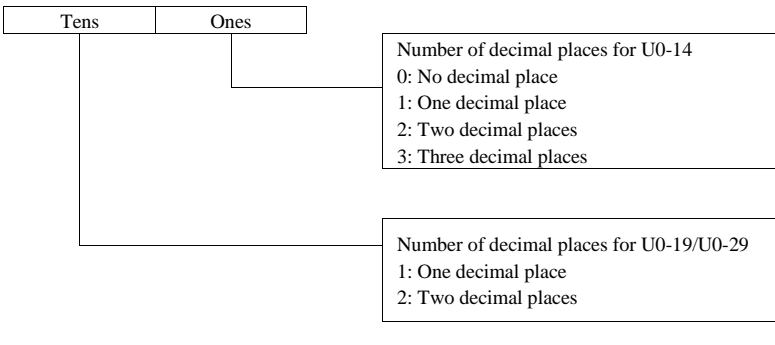

P8 Group - Auxiliary Function Parameters

P8-00	Jog frequency reference	
	0.00 Hz to the maximum frequency	2.00 Hz

P8-01	Jog acceleration time	
	0.0s to 6500.0s	20.0s
P8-02	Jog deceleration time	
	0.0s to 6500.0s	20.0s

P8-00 to P8-02 Define the parameters related to the operation of the point motion.

Jog acceleration time indicate time to accelerate from 0 Hz to P0-25.

Jog deceleration time indicate time to decelerate from P0-25 to 0 Hz.

P8-03	Acceleration time 2	
	0.00s to 65000s	Depending on model
P8-04	Deceleration time 2	
	0.00s to 65000s	Depending on model
P8-05	Acceleration time 3	
	0.00s to 65000s	Depending on model
P8-06	Deceleration time 3	
	0.00s to 65000s	Depending on model
P8-07	Acceleration time 4	
	0.00s to 65000s	0.0s
P8-08	Deceleration time 4	
	0.00s to 65000s	0.0s

P8-03 to P8-08 indicates the acceleration/deceleration time 2 to 4.

P8-09	Frequency jump 1	
	0.00 Hz to the maximum frequency	0.00 Hz
P8-10	Frequency jump 2	
	0.00 Hz to the maximum frequency	0.00 Hz
P8-11	Frequency jump band	
	0.00 Hz to the maximum frequency	0.00 Hz

The frequency jump function enables the inverter to avoid mechanical resonance point of load. The drive can be set with two separate frequencies, as shown below:

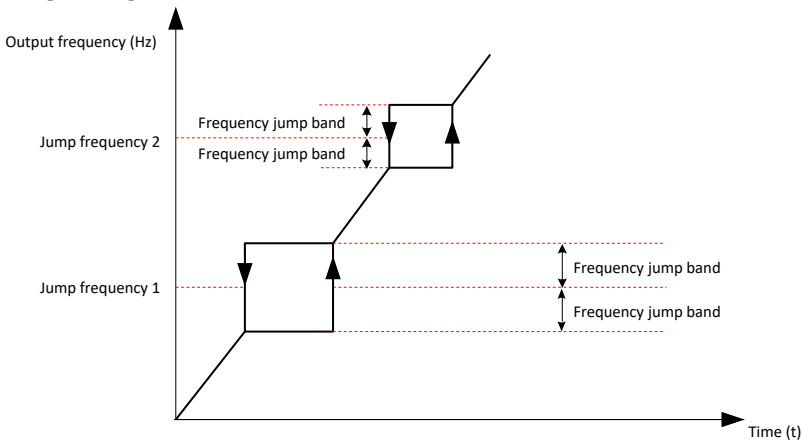

Figure 6-18 Schematic diagram of jump frequency and range

P8-12	Forward/Reverse run switchover dead-zone time	
	0.0s to 3000.0s	0.0s

Refers to the wait and hold time after the output frequency of the inverter drops to zero when the inverter receives the reverse operation command and transitions from the current operation direction to the opposite operation direction, as shown in the figure below.

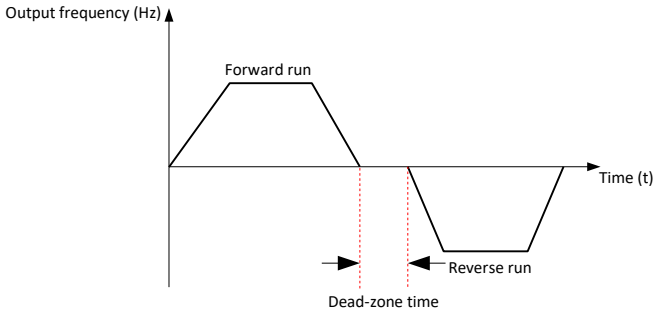

Figure 6-19 Schematic diagram of forward and reverse dead zone time

P8-13	Reverse RUN selection	
	0 to 1	0

0: Disabled
1: Enabled

If this parameter is 1 and the frequency is negative, the device runs in zero frequency.

P8-14	Running mode when frequency reference lower than frequency lower limit	
	0 to 2	0

0: Run at frequency reference lower limit

When the operating frequency is lower than the lower limit frequency, the lower limit frequency is used.

1: Stop

When the operating frequency is lower than the lower limit frequency, the inverter will stop.

2: Run at zero speed

When the operation frequency is lower than the lower limit frequency, the operation frequency is zero.

P8-15	Droop rate	
	0.00% to 10.00%	0.00%

The droop control allows for a small speed difference between the master station and the slave station, thus avoiding conflict between them. The default value of this parameter is 0.00Hz. The droop rate needs to be adjusted only when both master and slave are in speed control mode. A proper droop rate is gradually obtained during drive running. Therefore, do not set P8-15 to a very large value. Otherwise, steady speed will decline obviously when load is very large. You must set this parameter in both master and slave.

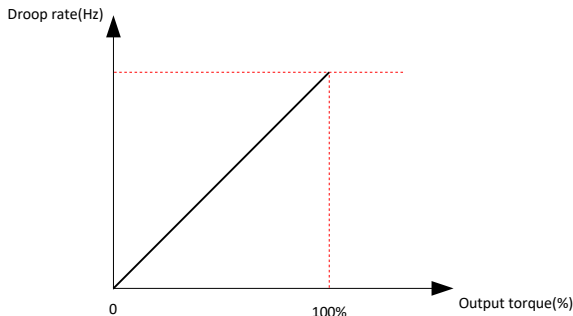

Figure 6-20 Schematic diagram of relationship between droop speed and output torque

$$\text{Droop speed} = \text{rated motor frequency} * \text{output torque} * (\text{P8-15} / 10)$$

Suppose that P8-15 is set to 10%, rated motor frequency is 50 Hz, and output torque is 50%. Actual drive frequency = 50 Hz – 50 * 50% * (1.00/10) = 47.5 Hz.

P8-16	Accumulative power-on time threshold	
	0h to 65000h	0h

When the accumulative power-on time (P7-13) reaches the set value of P8-16, the switch output terminal of the inverter outputs a valid signal.

P8-17	Accumulative running time threshold	
	0h to 65000h	0h

When the accumulative running time (P7-09) reaches the set value of P8-17, the switch output terminal of the inverter outputs effective signals.

P8-18	Startup protection selection	
	0 to 1	1

0: Disabled

1: Enabled

To prevent the danger caused by motor operation during power on or fault reset when the user is unaware of the situation.

Case 1: If the running command is valid during power-on (for example, the terminal is closed before power-on), the inverter does not respond to the running command. The user must remove the running command and run the inverter only when the running command is valid again.

Case 2: If the running command is effective when the inverter fault is reset, the inverter does not respond to the running command, the running command must be removed first to eliminate the running protection state.

P8-19	Frequency detection value 1	
	0.00 Hz to the maximum frequency	50.00 Hz
P8-20	Frequency detection hysteresis 1	
	0.0% to 100.0% (FDT1 level)	5.0%

P8-19 to P8-20 is used to set the detection value of the output frequency and the hysteresis of the output action lifting. The hysteresis is only effective in the deceleration process, and the detection does not lag in the acceleration process.

P8-21	Detection width of target frequency reached	
	0.0% to 100.0% (maximum frequency)	0.0%

This function sets the detection width of the frequency reference, the value is relative to the maximum frequency.

P8-22	Jump frequency function	
	0 to 1	0

For details check NO.10 item function description of discrete input terminal (P4-00 to P4-06).

P8-25	Switchover frequency of acceleration time 1 and acceleration time 2	
	0.00 Hz to the maximum frequency	0.00 Hz
P8-26	Switchover frequency of deceleration time 1 and deceleration time 2	
	0.00 Hz to the maximum frequency	0.00 Hz

This function selects acceleration/deceleration time according to running frequency range during drive running. This function is active only when motor 1 is selected and acceleration/deceleration time is not switched over via external Y terminal.

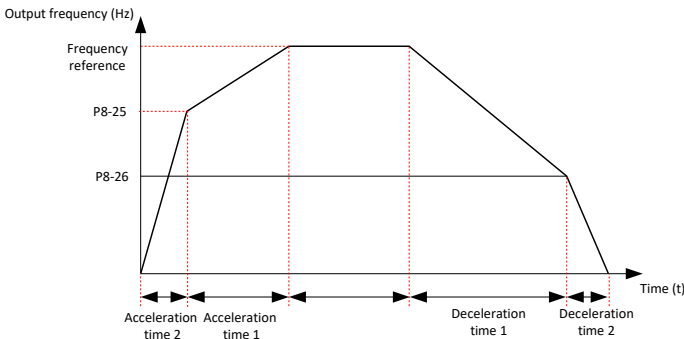

Figure 6-21 Schematic diagram of acceleration and deceleration time switch

P8-27	Set highest priority to terminal JOG function	
	0 to 1	0

0: Disabled

1: Enabled

This function parameter determines whether to set the highest priority to terminal JOG function. If this function is enabled and any of P4-00 to P4-09 is set to 4 (forward jog) or 5 (reverse jog) becomes active, the inverter enters jog running status immediately.

P8-28	Frequency detection value 2	
	0.00 Hz to the maximum frequency	50.00 Hz
P8-29	Frequency detection hysteresis 2	
	0.0% to 100.0% (FDT2 level)	5.0%

The parameter Settings for frequency detection value 2 are the same as those for P8-19 to P8-20.

P8-30	Detection of frequency 1	
	0.00 Hz to the maximum frequency	50.00 Hz
P8-31	Detection width of frequency 1	
	0.0% to 100.0% (maximum frequency)	0.0%
P8-32	Detection of frequency 2	
	0.00 Hz to the maximum frequency	50.00 Hz
P8-33	Detection width of frequency 2	
	0.0% to 100.0% (maximum frequency)	0.0%

Detection of frequency 1: when the operating frequency is within the detection range of P8-30 Detection of frequency 1), the switch output effective signal.

Frequency detection range: $[P8-30-P8-31 * P0-10]$ to $[P8-30 + P8-31*P0-10]$.

Detection of frequency 2: when the operating frequency is within the detection range of P8-32 (Detection of frequency 2), effective signal will be output.

Frequency detection range: $[P8-32-P8-33 * P0-10]$ to $[P8-32 + P8-33*P0-10]$.

P8-34	Zero current detection level	
	0.0% to 300.0%	5.0%
P8-35	Zero current detection delay	
	0.01s to 600.00s	0.10s

P8-34 The detection range of zero current is defined as 0 to P8-34 * P1-03, the percentage of which corresponds to the rated current of the motor.

If output current of the inverter is equal to or smaller than the value set in P8-34 and the duration exceeds the value set in P8-35, digital output terminal set for function 34 becomes on.

P8-36	Output overcurrent threshold	
	0.0% to 300.0% (rated motor current)	200.0%
P8-37	Output overcurrent detection delay time	
	0.00s to 600.00s	0.00s

0.0% means no detection. When it is not zero, if the drive's output current is equal to or smaller than the value set in P8-36 and the duration exceeds the value set in P8-37, digital output terminal set for function 36 becomes on.

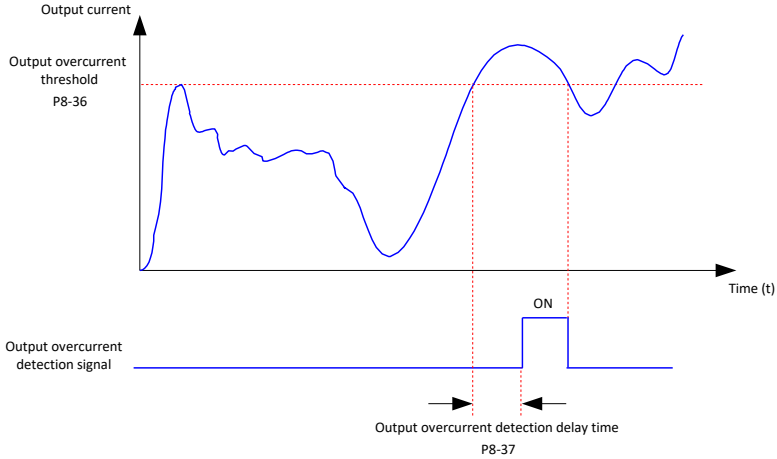

Figure 6-22 Schematic diagram of detecting output current overload

P8-38	Detection level of current 1	0.0% to 300.0% (rated motor current)	100.0%
	P8-39	Detection width of current 1	0.0% to 300.0% (rated motor current)
P8-40	Detection level of current 2	0.0% to 300.0% (rated motor current)	100.0%
	P8-41	Detection width of current 2	0.0% to 300.0% (rated motor current)

P8-38 to P8-41 define the n detection level of current 1/2 and detection width of current, as shown in the figure below:

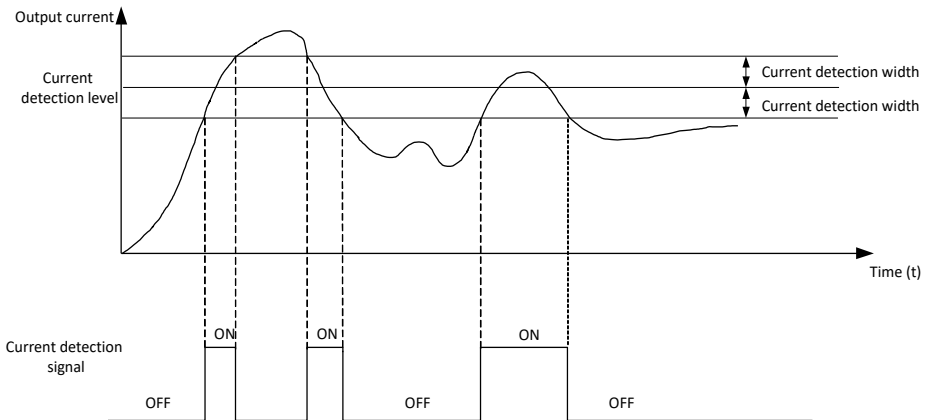

Figure 6-23 Arbitrary arrival current sequence diagram

P8-42	Timing function	0 to 1	0
-------	-----------------	--------	---

P8-43	Running time setting channel	0
	0: Set by P8-44 (Running time) 1: AI1 2: AI2 3: Panel potentiometer setting (100% of analog input corresponds to the value of P8-44)	
P8-44	Running time	0.0 min
	0.0 min to 6500.0 min	

These function parameters define the timing function of the drive.

P8-42 indicates whether to enable the timing function:

0: Disabled

1: Enabled

P8-43 is the setting channel of timing running time:

0: Set by P8-44 (Running time)

1: AI1

2: AI2

3: Panel potentiometer setting(100% of analog input corresponds to the value of P8-44)

Note: Analog input range corresponds to P8-44; P8-43 indicates the scheduled running time, in minute.

When P8-42=1, the timing starts from the start of the inverter, and automatically stops when it reaches the running time (P8-44).

P8-45	AI1 input voltage lower limit	3.10 V
	0.00 V to P8-46 (AI1 input voltage upper limit)	
P8-46	AI1 input voltage upper limit	6.80 V
	0.00 V to P8-46 (AI1 input voltage upper limit)	

If AI1 input is larger than P8-46 or smaller than P8-45, digital output terminal set for function 31 becomes on. These two function parameters indicate whether AI1 input voltage is in the setting range.

P8-47	IGBT temperature threshold	75°C
	0°C to 100°C	

This function parameter sets IGBT temperature threshold. When heatsink temperature reaches the value set in P8-47, digital output terminal set for function 35 becomes on.

P8-48	Cooling fan working mode	0
	0 to 1	

0: Working during running

1: Working continuously

P8-53	Running time threshold this time	0.0 min
	0.0min to 6500.0min	

When running time threshold this time reaches the set value of P8-53, the switching quantity terminal of the inverter outputs effective signals. This value is valid only for the current run time and does not accumulate the previous run time.

P8-54	Output power correction coefficient	100.0%
	0.00% to 200.0%	

When output power (U0-05) is not equal to expected value, perform linear correction via this parameter.

P9 Group - Parameters of Fault and Protection

P9-00	Motor overload protection	1
	0 to 1	

0: Disabled

The motor overload protection is disabled.

1: Enabled

The inverter determines whether the motor is overloaded according to the inverse time-lag curve of motor overload protection.

P9-01	Motor overload protection gain	
	0.20 to 10.00	1.00

If the motor overload current level and overload protection time need be adjusted, modify setting of P9-01.

P9-02	Motor overload pre-warning coefficient	
	50% to 100%	80%

The inverter has the motor overload pending function that reminds of motor overload in advance through digital output function 6. The motor overload protection function has an inverse load-time characteristics. The inverse load-time characteristic is shown in the following figure.

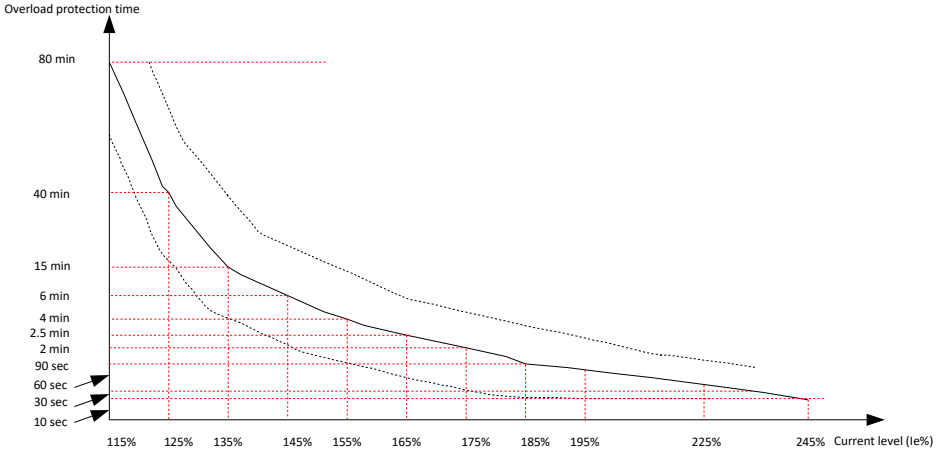

Figure 6-24 Inverse time-lag curve

When motor running current reaches 175% of rated motor current and motor runs at this level for 2 minutes, F11 (motor overload) is detected. When motor running current reaches 115% of rated motor current and motor runs at this level for 80 minutes, F11 is detected. Suppose that rated motor current is 100 A.

P9-01 = 1.00: According to Figure 7-47, when motor running current reaches 125 A (125% of 100 A) and motor runs at 125 A for 40 minutes, F11 is detected.

P9-01 = 1.20: According to Figure 7-47, when motor running current reaches 125 A (125% of 100 A) and motor runs at 125 A for $40 * 1.2 = 48$ minutes, F11 is detected.

Note: The maximum overload time is 80 minutes, the minimum time is 10 seconds.

For example, application requires detect of F11 when motor runs at 150% of rated motor current for two minutes. According to Figure 7-47, 150% (I) is in the range of 145% (I1) and 155% (I2). 145% corresponds to overload protection time 6 minutes (T1) and 155% corresponds to overload protection time 4 minutes (T2). You can calculate overload protection time T corresponding to 150% from the following formula:

$$T = T1 + (T2 - T1) * (I - I1) / (I2 - I1) = 4 + (6 - 4) * (150\% - 145\%) / (155\% - 145\%) = 5 \text{ minutes}$$

Then calculate motor overload protection gain from the following formula:

$$P9-01 = \text{Desired overload protection time} / \text{Corresponding overload protection time} = 2 / 5 = 0.4$$

Note: the user needs to correctly set the p9-01 value according to the actual overload capacity of the motor. If this parameter is too large, the motor may be damaged by overheating and the inverter may not alarm and protect in time.

P9-02 Parameter Settings:

The inverter has the motor overload pending function that reminds of motor overload in advance through digital output function 6. This parameter is calculated according to the percentage of time that the motor keeps running at a certain overload point without reporting overload failure.

For example, On the condition that P9-01 = 1.00 and P9-02 = 80%, when motor running current reaches 145% of rated motor current and motor runs at this level for 80% * 6 = 4.8 minutes, Y terminal or fault relay outputs the motor overload pending signal.

Motor overload warning function is used to output a warning signal from the switching quantity terminal before motor overload fault protection. The warning coefficient is used to determine how much warning should be given before motor overload protection. The larger the value is, the smaller the amount of early warning is. When the cumulative output current of the inverter is greater than the product of overload time and motor overload warning coefficient (P9-02), the switch output terminal outputs motor overload warning signal. When P9-02 = 100%, the motor overload pending and the motor overload protection are performed simultaneously.

P9-03	Overvoltage protection gain	
	0 to 100	30

Increasing P9-03 can improve the control effect of bus voltage, but the output frequency will fluctuate. If the output frequency fluctuates greatly, the value can be reduced appropriately.

P9-04	Overvoltage protection voltage	
	330.0V to 800.0V	720.0V

This parameter defines the action voltage of stall overvoltage protection.

Three-phase 380 to 480V: 650.0 V to 800.0 V. Default: 720.0 V.

One-phase 200 to 240V: 330.0 V to 420.0 V. Default: 380.0 V.

P9-07	Detection of short-circuit to ground	
	00 to 11	01

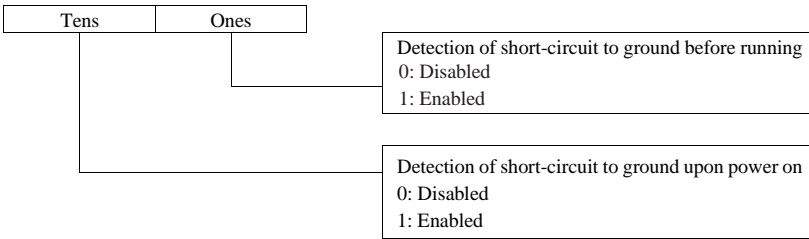

P9-08	Braking unit applied voltage Braking unit applied voltage	
	650.0 V to 800.0 V	Depending on model

Three-phase 380 to 480V: 650.0 V to 800.0 V. Default: 690.0 V.

One-phase 200 to 240V: 330.0 V to 420.0 V. Default: 360.0 V.

When the DC bus voltage exceeds this value, the brake resistance starts to brake energy consumption, so that the DC voltage falls back.

P9-09	Auto reset times	
	0 to 30	0

This function parameter sets permissible times of auto fault reset. If reset times exceed the value set in this parameter, the inverter will keep fault status.

P9-10	Selection of digital output terminal action during auto reset	
	0: Not act 1: Act	1

This function parameter decides whether digital output terminal set for fault output acts during the fault reset.

P9-11	Delay of auto reset	
	0.1s to 100.0s	1.0s

This function parameter sets the delay of auto reset after the inverter detects a fault.

P9-12	Input phase loss/ Contactor protection	
	00 to 11	11

This function parameter determines whether to perform input phase loss or pre-charge relay protection.

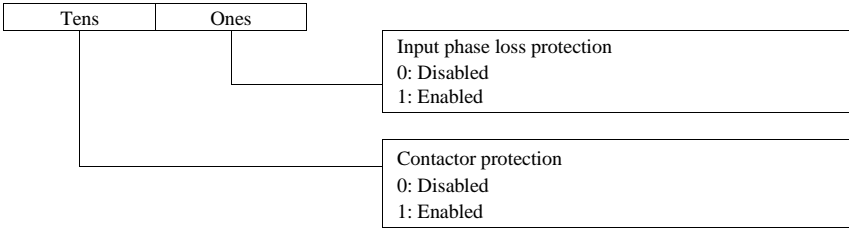

P9-13	Output phase loss protection	
	00 to 11	01

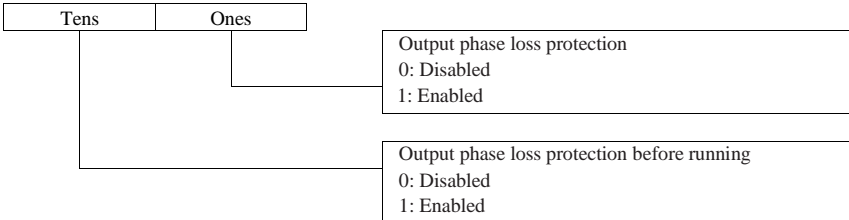

Units position: It determines whether to perform output phase loss protection. If protection is disabled but power output phase loss occurs, the inverter does not detect the fault. At this moment, actual current is larger than the current displayed on the operating panel.

Tens position: It takes about several seconds to detect output phase loss during running. In low frequency running application or application where risks exist in start with phase loss, set this position to 1. In applications which have strict requirements on start time, set this position to 0.

P9-14	1st fault type	
	0 to 55	-
P9-15	2nd fault type	
	0 to 55	-
P9-16	3rd (latest) fault type	
	0 to 55	-

For recorded inverter fault types, see the description in the parameter table.

P9-17	Frequency upon 3rd (latest) fault	
	0.00Hz to 655.35Hz	0.00Hz
P9-18	Current upon 3rd (latest) fault	
	0.00Hz to 655.35A	0.00A
P9-19	Bus voltage upon 3rd (latest) fault	
	0.0V to 6553.5V	0.0V
P9-20	Input terminal state upon 3rd (latest) fault	
	0 to 9999	0
P9-21	Output terminal state upon 3rd (latest) fault	
	0 to 9999	0
P9-22	inverter state upon 3rd (latest) fault	
	0 to 65535	0
P9-23	Power-on time upon 3rd (latest) fault	
	0s to 65535s	0s
P9-24	Running time upon 3rd (latest) fault	
	0.0s to 6553.5s	0.0s

Parameters P9-17 to P9-24 Record information about the latest fault.

P9-27	Frequency upon 2nd fault	
	0.00Hz to 655.35Hz	0.00Hz
P9-28	Current upon 2nd fault	
	0.00A to 655.35A	0.00A
P9-29	Bus voltage upon 2nd fault	
	0.0V to 6553.5V	0.0V
P9-30	X state upon 2nd fault	
	0 to 9999	0
P9-31	Output terminal state upon 2nd fault	
	0 to 9999	0
P9-32	inverter state upon	
	0 to 65535	0
P9-33	Power-on time upon 2nd fault	
	0s to 65535s	0s
P9-34	Running time upon 2nd fault	
	0.0s to 6553.5s	0.0s

Parameters P9-27 to P9-34 record information about the previous fault.

P9-37	Frequency upon 1st fault	
	0.00Hz to 655.35Hz	0.00Hz
P9-38	Current upon 1st fault	
	0.00A to 655.35A	0.00A
P9-39	Bus voltage upon 1st fault	
	0.0V to 6553.5V	0.0V
P9-40	X state upon 1st fault	
	0 to 9999	0
P9-41	Output terminal state upon 1st fault	
	0 to 9999	0
P9-42	inverter state upon 1st fault	
	0 to 65535	0
P9-43	Power-on time upon 1st fault	
	0s to 65535s	0s
P9-44	Running time upon 1st fault	
	0.0s to 6553.5s	0.0s

Parameters P9-37 to P9-44 record information about the first fault.

P9-47	Fault protection action selection 1	
	0 to 22222	00000

Parameter P9-47 defines the action of the inverter when a fault occurs from 11 to 16.

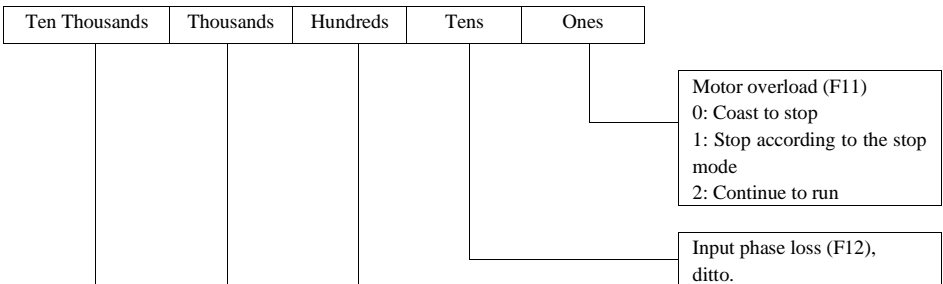

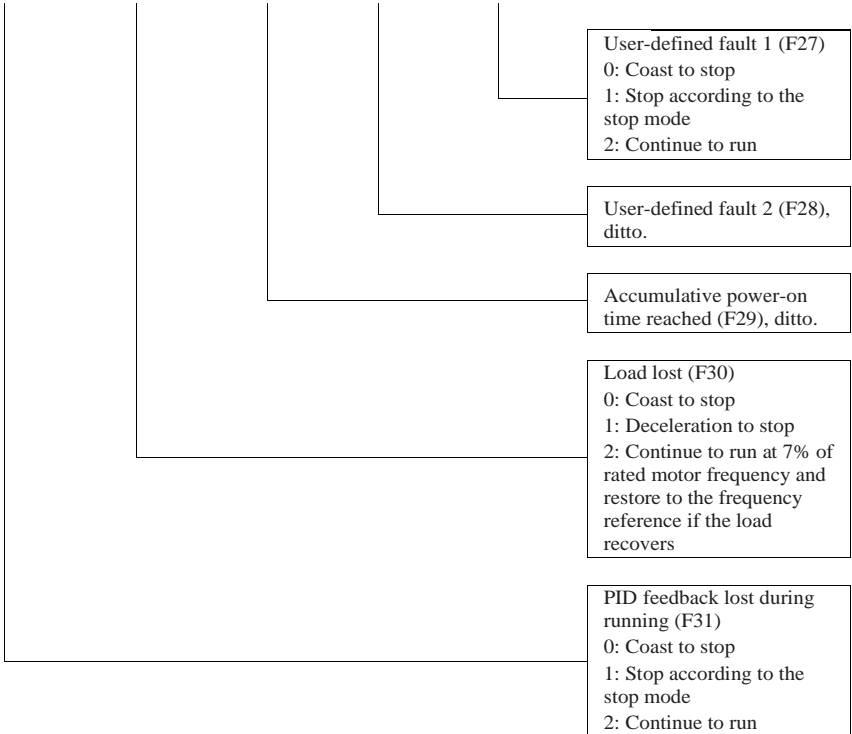

P9-50	Fault protection action selection 4	
	0 to 22222	00000

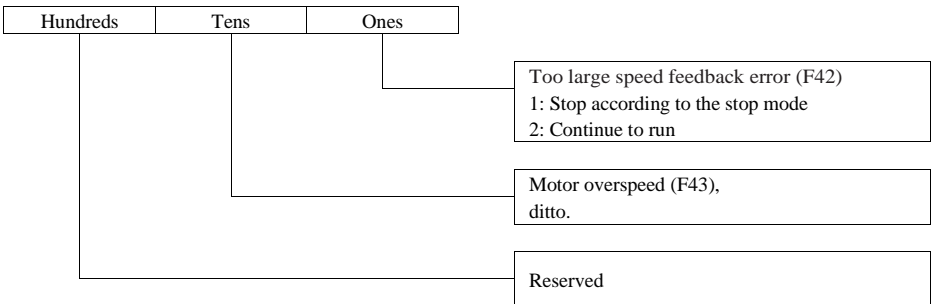

P9-54	Frequency selection for continuing to run upon fault	
	0 to 4	0

When a fault occurs and the troubleshooting mode is to continue, the inverter runs at the frequency determined by this parameter setting mode.

0: Current running frequency

1: Frequency reference

- 2: Frequency upper limit
- 3: Frequency lower limit
- 4: Backup frequency upon abnormality

P9-55	Backup frequency upon fault	
	0.0% to 100.0%(100.0% corresponds to P0-10)	100.0%

When P9-54 =4, run at the frequency set by this parameter when a fault occurs and the operation continues when the fault occurs.

P9-59	Power dip ride- through function selection	
	0 to 2	0

- 0: Disabled
- 1: Bus voltage constant control
- 2: Decelerate to stop

The function of power dip ride-through is shown in the figure below:

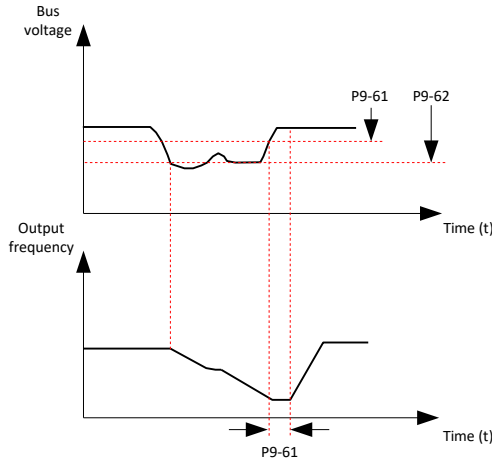

Figure 6-25 Schematic diagram of Power dip ride- through process

P9-60	Threshold of power dip ride-through function disabled	
	80% to 100%	85%

For the 380V voltage class, 100% corresponds to 540V.

P9-61	Judging time of bus voltage recovering from power dip	
	0.0 to 100.0s	0.5S

It is valid only when P9-59=1.

P9-62	Threshold of power dip ride-through function enabled	
	60% to 100%	80%

For the 380V voltage class, 100% corresponds to 540V.

P9-63	Load lost protection	
	0: Disabled 1: Enabled	0
P9-64	Load lost detection level	
	0.0 to 100.0%	10.0%
P9-65	Load lost detection time	
	0.0 to 60.0s	1.0s

These function parameters define the load lost protection function.

When output current of the inverter falls below detection level (P9-64) for longer than time set in P9-65, the inverter automatically reduces output frequency to 7% of rated frequency. Once load recovers during protection, the inverter accelerates to frequency reference.

P9-67	Overspeed detection level	
	0.0% to 50.0% (maximum frequency)	20.0%
P9-68	Overspeed detection time	
	0.0s: Not detected 0.1s to 60.0s	1.0s

These function parameters define motor overspeed detection that is effective only for vector control with speed sensor. When detected motor speed exceeds maximum frequency and the excess is larger than the value of P9-67 for longer than time set in P9-68, the inverter detects F43 and acts as selected in the tens position in P9-50.

If P9-68 is set to 0, motor overspeed detection is disabled.

P9-69	Detection level of speed error	
	0.0% to 50.0% (maximum frequency)	20.0%
P9-70	Detection time of speed error	
	0.0s: Not detected 0.1 to 60.0s	5.0s

When detected motor speed is different from frequency reference and the difference is larger than the value of P9-69 for longer than the time set in P9-70, the inverter detects F42 and acts as selected in the units position in P9-50.

If P9-70 is set to 0, Detection of speed error is disabled.

P9-71	Power dip ride-through gain Kp	
	0 to 100	40
P9-72	Power dip ride- through integral coefficient Ki	
	0 to 100	40

It is valid only when P9-59=1. If process of power dip ride-through is prone to undervoltage, increase Kp and Ki.

P9-73	Deceleration time of power dip ride-through	
	0 to 300.0s	20.0s

It is valid only when P9-59=2.

PA Group - PID Control Parameters

PA-00	PID reference setting channel	
	0 to 6	0

0: Set by PA-01 (PID digital setting)

1: AI1

2: AI2

3: Panel potentiometer

4: Pulse reference (X6)

5: Serial comms.

6: Multi-reference

PA-00 and PA-01 set input channel of PID reference.

Note:

a) PID reference is a relative value and ranges from 0.0% to 100.0%.

b) When PA-00 selects 6(Multi-reference), PC-51 (Reference 0 source) cannot select 5 (Serial comms).

c) When P0-03(main frequency reference setting channel selection) is set from non-PID to PID, LED display parameters of running and stop will change, and the parameter can be switched by pressing the shift key. Under the running state, the parameters displayed on the panel are set frequency (Hz), output current (A), set pressure (A,V), feedback pressure (Hz, A, V); The parameters displayed on the stop status panel are display set frequency (Hz), bus voltage (V), set pressure (A,V), feedback pressure (Hz, A, V). If there is a running command or the inverter is in the running state, the "RUN" indicator light is on, and the "RUN" light is off after the machine stops. The RUN indicator is off when the machine is stopped.

PA-01	PID digital setting	
	0.0 to PA-04	5.00

When PA-00 is 0, this parameter is valid. PID feedback ranges from 0.0% to 100.0%.

PA-02	PID feedback setting channel	
	0 to 8	0

PID feedback is a relative value and ranges from 0.0% to 100.0%.

- 0: AI1
- 1: AI2
- 2: Panel potentiometer
- 3: AI1-AI2
- 4: Pulse reference (X6)
- 5: Serial comms.
- 6: AI1 + AI2
- 7: Max. (|AI1|, |AI2|)
- 8: Min. (|AI1|, |AI2|)

PA-03	PID operation direction	
	0 to 1	0

0: Forward

When PID feedback is smaller than PID reference, the inverter increases output frequency.

1: Reverse

When PID feedback is smaller than PID reference, the inverter decreases output frequency.

PA-04	PID reference and feedback range	
	1.0 to 655.35	10.00

This value refers to the maximum value of the PID feedback. For convenience, the value is consistent with the gauge range of pressure feedback;

Case 1 : the maximum value of pressure feedback is 10.00kg. When PA-04 is set to 10.00kg, U0-16 will display 10.00 when the feedback pressure is 10.00kg.

Case 2 : if PA-04=10.00, when the feedback pressure is 0.00 to 10.00V signal, if the feedback signal is 5.00V, U0-16 will display 5.00; If PA-04=16.00 and the feedback signal is 5.00V, U0-16 will be displayed as 8.00;

PA-05	Proportional gain Kp1	
	0.0 to 1000.0	100.0
PA-06	Integral time Ti1	
	0.01s to 10.00s	0.50s
PA-07	Differential time Td1	
	0.000s to 10.000s	0.000s

PA-05 to PA-07 are parameter groups 1 controlled by PID. A large value tends to reduce present error, but too large setting will cause system oscillation. The shorter the integral time is, the faster the error will be predicted. But too short setting will cause overshoot or system oscillation. The longer the derivative time is, the faster the system will respond to the error. But too longer setting will cause vibration. During debugging, the proportional gain KP is adjusted first, and the integral time Ti is adjusted when KP remains unchanged. Usually to stabilize a value and then adjust another related parameter value.

PA-08	PID output limit in reverse direction	
	0.00Hz to Max. frequency (P0-10)	0.00 Hz

When frequency reference setting channel is purely PID reference, PA-08 limits the output in reverse direction. When frequency reference setting channel is main frequency reference + PID reference, PA-08 limits the calculation result in reverse direction.

PA-09	PID error limit	
	0.0% to 100.0%	0.0%

When the difference between the PID given and the feedback is less than PA-09, the PID stops adjusting and the PID controller output remains unchanged. Set in unit of %, both positive and negative limits are valid.

PA-10	PID differential limit	
	0.00% to 100.00%	0.10%

In PID reference, differential is easy to cause system oscillation. Therefore, the differential function of PID is generally limited to a small range. Pa-10 is used to set the range of PID differential output.

PA-11	PID reference change time	
	0.00 to 650.00s	0.00s

PA-11 sets time it takes PID reference to change from 0.0% to 100.0%.

PA-12	PID feedback filter time	
	0.00 to 60.00s	0.00s

PA-12 filters the PID feedback, which helps to lower interference on PID feedback but slows system response performance.

PA-13	PID output filter time	
	0.00 to 60.00s	0.00s

PA-13 filters the PID output frequency, which helps to drop off mutation of the inverter output frequency but slows system response performance.

PA-14	Stop mode in hibernating state	
	0 to 1	0

PA-14 defines the stopping mode when the PID is running and the inverter enters the hibernate state,

PA-15	Proportional gain Kp2	
	0 to 1000.0	20.0

PA-16	Integral time T _{I2}	
	0.01s to 10.00s	2.00s

PA-17	Differential time T _{d2}	
	0.000s to 10.000s	0.000s

PA-15 to PA-17 are PARAMETER groups 2 controlled by PID, and have the same functions as parameters PA-05 to PA-07.

PA-18	PID parameter switchover condition	
	0 to 3	0

0: No switchover

1: Switchover using X

If PID parameters switchover is done via X terminal (PA-18 = 1), PID parameters are PA-05 to PA-07 when terminal set for this function becomes off; PID parameters are PA-15 to PA-17 when terminal set for this function becomes on.
2: Auto switchover based on PID error

When the absolute value of the deviation between the given and the feedback is less than PID error 1 for auto switchover (PA-19), PID selects parameter group 1. Given that the absolute value of the deviation between PID and feedback is greater than PID error 2 for auto switchover (PA-20), PID selects parameter group 2. When the deviation between given and feedback is between PID error 1 for auto switchover and PID error 2 for auto switchover, PID parameter is linear interpolation value of two groups of PID parameters.

3: Auto switchover based on running frequency

When automatic switching is selected according to the operating frequency, and when the inverter runs between 0 and maximum frequency, PID parameter is linear interpolation value of two groups of PID parameters.

PA-19	PID error 1 for auto switchover	
	0.0% to PA-20 (PID error 2 for auto switchover)	20.0%
PA-20	PID error 2 for auto switchover	
	PA-19 (PID error 1 for auto switchover) to 100.0%	80.0%

In these two parameters, the value 100% corresponds to the maximum deviation value given with the feedback, which is valid when PA-18=2.

PA-21	PID initial value	
	0.0% to 100.0%	0.0%

PA-22	PID initial value active time	
	0.00 to 650.00s	0.00s

When the inverter starts, the PID function turns active only after PID output is fixed at PID initial value (PA-21) for time set in PA-22.

PA-25	PID integral property	
	Tens: Whether to stop integral operation when the PID output reaches the limit 0: Continue integral operation 1: Stop integral operation Ones: Integral separation 0: Disabled 1: Enabled	00

Ones:

When integral operation is invalid, integral operation is invalid regardless of whether multi-function input terminal is valid or not. When integral separation is in effect, PID integral stops calculating when the integration of the multi-function input terminal is suspended (function 22). At this time, PID is only valid for proportion and differentiation.

Tens:

When the PID output reaches the maximum or minimum value, you can choose whether to stop the integration. If stop integral is selected, PID integral will stop calculation. This function helps reduce PID overshoot.

PA-26	Detection level of PID feedback loss	
	0.0% to 100.0%	0.0%

Note: 0 means no detection; 100.0% corresponding to output full range.

PA-27	Detection time of PID feedback loss	
	0.0s to 20.0s	0.0s

When PID feedback is smaller than the value set in PA-26 for time set in PA-27, inverter detects F31.

PA-28	Selection of PID operation at stop	
	0: Disabled 1: Enabled	0

This function parameter determines whether to continue PID operation when the inverter stops. In general application, PID should stop operation in shutdown state.

PA-29	Hibernating frequency	
	0.00Hz to Max. frequency (P0-10)	0.00Hz
PA-30	Hibernating pressure	
	PA-32 to 100.0% (Setting pressure)	95.0%
PA-31	Hibernating delay time	
	0.0 to 6500.0s	30.0s
PA-32	Wakeup pressure	
	0.0 to PA-30 (Hibernating pressure)	80.0%
PA-33	Wakeup delay time	
	0.0 to 6500.0s	3.0s

PA-29 to PA-33 define the parameters related to hibernating and wake up under the PID function.

When the output frequency of the inverter is less than hibernating frequency (PA-29), and the feedback pressure is greater than or equal to hibernating pressure (PA-30), and the duration of the running condition exceeds the hibernating delay time (PA-31), the inverter enters the hibernating state, and "SLEEP" is displayed on the operation panel.

Under factory conditions, the hibernating frequency PA-29 = 0.00Hz, the inverter will not enter the hibernating state, the user needs to set the appropriate value of PA-29 according to the actual working conditions, generally the value should be greater than 30.00Hz.

When the inverter is in the hibernating state (" SLEEP "is displayed on the operation panel), if the feedback pressure is lower than the wake-up pressure (PA-32), and the duration of the working condition exceeds the wake-up delay time (PA-33), the inverter will run automatically.

Note: When the inverter is in the hibernating state, press the "STOP" key on the operation panel, and the inverter will exit the hibernating state and enter the normal stop state. If the terminal or communication control start/stop command, revoke the run command, the inverter will also exit the hibernating state, enter the stop state.

PA-34	Water shortage detection frequency	
	0.00Hz ~ Max. frequency (P0-10)	48.00Hz
PA-35	Water shortage detection pressure	
	0.00 to PA-04	0.00

PA-36	Water shortage detection time	
	0 to 65000s	60s
PA-37	Water shortage restart time	
	0 to 65000s	600s
PA-38	Water shortage restart times	
	0 to 9999	6

PA-34 to PA-38 define related parameters such as water shortage fault and restart in water shortage state under PID function.

When the output frequency is lower than the water shortage detection frequency (PA-34), and the feedback pressure is lower than the water shortage detection pressure (PA-36), and the state duration exceeds the water shortage detection time (PA-36), the inverter enters the water shortage protection state. At this time, the inverter stops (the stopping mode is set by PA-14), and " H-H-O " is displayed on the operation panel indicating that the system is in the state of water shortage. After enter the stop key on the operation panel or revoke the running command, the inverter will exit the state of water shortage and enter the normal stop state.

PA-37 defines the time interval for the inverter to restart under the condition of water shortage.

PA-38 defines the maximum number of restart under water shortage. When the number of restarts exceeds the value of PA-38, the inverter will not restart.

Pb Group - Parameters of Wobble Function, Fixed Length and Count

Pb-00	Wobble setting mode	
	0 to 1	0

0: Relative to central frequency

1: Relative to maximum frequency

Pb-01	Wobble amplitude	
	0.0% to 100.0%	0.0%

The wobble amplitude is the percentage relative to the benchmark frequency set by Pb-00.

Pb-02	Wobble step	
	0.0% to 50.0%	0.0%

In the process of wobble frequency, the amplitude of rapid decline after the frequency reaches the upper limit of wobble frequency, also refers to the amplitude of rapid rise after the frequency reaches the lower limit of wobble frequency. This value is the percentage relative to the wobble amplitude (Pb-01). If Pb-01 is set to 0.0%, there will be no jump frequency.

Pb-03	Wobble cycle	
	0.0s to 3000.0s	10.0s

The parameter defines the time of a complete cycle of the wobble rise and fall process.

Pb-04	Triangular wave rising time	
	0.0% to 100.0%	50.0%

The parameter defines the running time $Pb-03 \times Pb-04$ seconds in the ascending stage of pendulum frequency and $Pb-03 \times (1-Pb-04)$ seconds in the descending stage. Please refer to the description in the figure below.

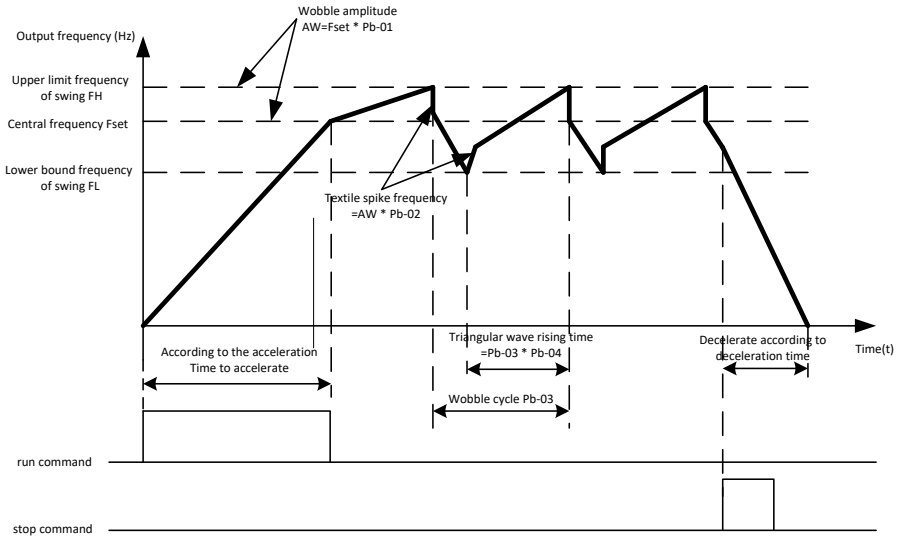

Figure 6-26 Diagram of wobble function

Pb-05	Set length	
	0m to 65535m	1000m

The inverter of this model has the function of fixed-length control, and the length pulse can only be collected by X6 terminal. It is necessary to set the function selection of X6 terminal to function 27 (Length count input). This function parameter selects base value of wobble amplitude, in meters.

Pb-06	Actual length	
	0m to 65535m	0m

Actual length (Pb-06) = Number of pulses sampled by X / Pb-07 (Number of pulses per meter).

Pb-07	Number of pulses per meter	
	0.1 to 6553.5	100.0
Pb-08	Set count value	
	1 to 65535	1000
Pb-09	Designated count value	
	1 to 65535	1000

The count needs to be collected through the X terminal (X6 terminal must be used at high pulse frequency), and the X terminal function is set to 25 (Counter input). Note: Pb-09(Designated count value) should be less than or equal to Pb-08(Set count value).

In the figure below, the count needs to be collected through the X terminal, and the X terminal function should be set to 25(Counter input). If the value of the meter reaches the setting value (Pb-08), the multi-functional switching quantity terminal outputs "set count value reaches" ON signal; When the count reaches designated count value (Pb-09), the multi-function switching quantity terminal outputs "designated count value reaches" ON signal.

Assuming Pb-08 =12 and Pb-09 =7, the sequence is shown in the figure below:

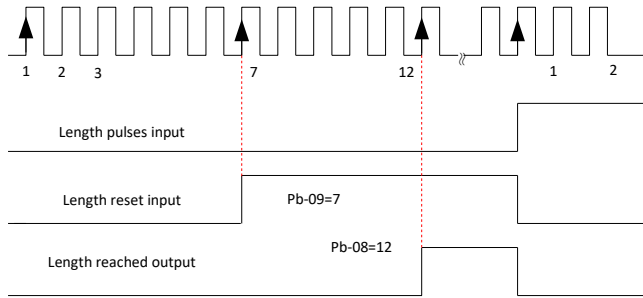

Figure 6-27 Diagram of counting function

Note:

- a) For high pulse frequency, use terminal X6.
- b) You cannot allocate "Set counting value reached" function and "Designated counting value reached" function to the same digital output terminal.
- c) The counter keeps counting in the drive running/stop status. It stops counting until the set counting value is reached.
- d) The counting value is retentive at power down.
- e) An automatic stop system can be implemented by connecting the output counting value reached signal of digital output terminal to the stop input terminal.

PC Group - Parameters of Multi-Reference and Simple PLC Function

PC-00 to PC-15	Reference 0 to Reference 15	
	-100.0% to 100.0%	0.0%

Multi-reference is a relative value and is a percentage of P0-10 (max. frequency). Whether the setting is positive or negative determines drive running direction. If negative, it indicates that the inverter runs in reverse direction, and driver will skip to another segment.

The default acceleration and deceleration times are P0-17 and P0-18 respectively.

PC-16	Simple PLC running mode	
	0 to 2	0

0: Stop after running one cycle

The inverter stops after running one cycle, and will not start until it receives a new RUN command.

1: Keep final values after running one cycle

The inverter keeps final running frequency and direction after running one cycle.

2: Repeat after running one cycle

The inverter automatically starts another cycle after running one cycle, and will not stop until receiving stop command.

PC-17	Simple PLC retentive selection	
	00 to 11	00

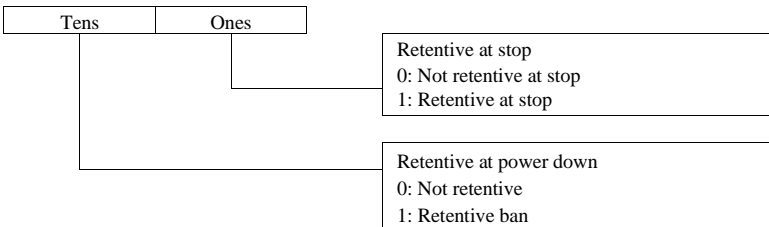

Note: You must set the same baud rate in the master and slave. Otherwise, communication shall fail.

Pd-01	Modbus data format symbol	
	0 to 3	3

0: No check (8,N,2)

1: Even parity check(8,E,1)

2: Odd parity check(8,O,1)

3: No check, data format(8,N,1)

Note that data format of host computer must be the same as that of inverter. Otherwise, communication shall fail.

Pd-02	Local address	
	0 to 247	1

When local address is set to 0 (that is, broadcast address), inverters can only receive and execute broadcast commands of host computer, but will not respond to host computer. This parameter is used to set address of inverter. This address is unique (except broadcast address), which is basis for point-to-point communication between host computer and inverter.

Pd-03	Modbus response delay	
	0 to 20ms	2

This parameter sets interval between inverter completing receiving data and inverter sending data to host computer.

If response delay is shorter than system processing time, system processing time shall prevail.

If response delay is longer than system processing time, system sends data to host computer only after response delay is up.

Pd-04	Serial port communication timeout	
	0 to 60.0s	0.0

When this parameter is set to 0.0s, system does not detect communication timeout. Generally, this parameter is set to 0.0s. In applications with continuous communication, you can use this parameter to monitor communication status.

When inverter does not receive communication signal within time set in this parameter, it detects communication timeout fault (F16).

Pd-05	Modbus protocol selection and PROFIBUS-DP data frame	
	0 to 1	1

0: Non-standard Modbus protocol

When reading a command, the slave machine returns one more byte than the standard Modbus protocol.

1: Standard Modbus protocol

Pd-06	Current resolution read by communication	
	0 to 1	0

This parameter is used to set unit of output current read by communication.

0: 0.01 A (valid when ≤ 55 kW)

1: 0.1 A

PP Group - User Password Parameters

PP-00	User password	
	0 to 65535	0

PP-00 is the user password setting parameter: when this value is not zero, the user must enter the password correctly to enter the function parameter and user change parameter mode; to cancel the user password, set PP-00 to zero.

PP-01	Parameter initialization	
	0 to 501	0

0: No operation

01: Restore factory parameters except motor parameters

After PP-01 is set to 1, most function parameters are restored to factory parameters, but motor parameters, fault record information, accumulative running time (P7-09), accumulative power-on time (P7-13), accumulative power consumption (P7-14), and heatsink temperature of IGBT (P7-07) are not restored.

02: Clear records

Clear fault records, accumulative running time (P7-09), accumulative power-on time (P7-13), and accumulative power consumption (P7-14).

03: Restore factory parameters including motor parameters

After PP-01 is set to 3, the motor parameters P1-01 to P1-10 are restored to the motor parameters of the original power model, the current loop PI parameter is also restored to the default value, and P0-22 is restored to 2.

04: Back up current user parameters

Back up the parameters set by the current user to restore the original Settings.

501: Restore user backup parameters

Restore the backup parameters by setting PP-01=4.

PP-02	Parameter display property	
	00 to 11	11

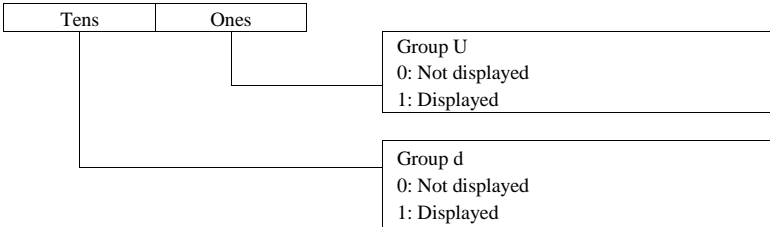

PP-03	Selection of individualized parameter display	
	00 to 11	00

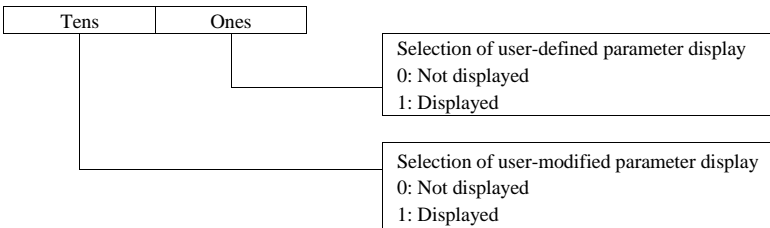

PP-04	Selection of parameter modification	
	0 to 1	00

0: Disabled
1: Enabled

d0 Group - Parameters of Torque Control and Limit

d0-00	Speed/Torque control selection	
	0 to 1	0

Speed/torque control mode is set by d0-00.

0: Speed control
1: Torque control

The inverter has two digital input functions related to torque control, function 29 "Torque control prohibited" and function 46 "Speed control/Torque control". The two functions must be used together with parameter d0-00 to implement switchover between speed control and torque control.

When function 46 is enabled, the control mode is determined by setting of d0-00. When function 46 is disabled, the control mode is reverse to setting of d0-00.

When function 29 is enabled, the inverter always run in speed control.

d0-01	Torque reference source in torque control	
	0 to 7	0

- 0: Set by d0-03
- 1: AI1
- 2: AI2
- 3: Panel potentiometer setting
- 4: Pulse reference
- 5: Communication reference
- 6: Min. (AI1, AI2)
- 7: Max. (AI1, AI2)

The full scale of 1-7 corresponds to d0-03.

Torque reference is a relative value. 100.0% corresponds to rated inverter torque.

d0-03	Torque digital setting in torque control	
	-200.0% to 200.0%	150.0%

In torque control mode, when d0-01 =0, d0-03 is the magnitude of the torque set value.

d0-05	Forward max. frequency in torque control	
	0.00 Hz to the maximum frequency	50.00 Hz
d0-06	Reverse max. frequency in torque	
	0.00 Hz to the maximum frequency	50.00 Hz

In torque control mode, the acceleration and deceleration time of the upper frequency limit is set by P8-07 (Acceleration time 4) and P8-08 (Deceleration time 4).

In the torque control mode, when the load torque is less than the output torque of the motor, the motor speed will continue to rise, in order to prevent the mechanical system to speed accidents, must limit the maximum speed of the motor in torque control (d0-05 / d0-06).

To dynamically change the maximum torque control frequency continuously, the upper limit frequency can be controlled.

d0-07	Acceleration time in torque control	
	0.00s to 650.00s	0.00s
d0-08	Deceleration time in torque control	
	0.00s to 650.00s	0.00s

In torque control mode, the difference between the electromagnetic torque of the motor and the load torque determines the change rate of the motor speed. Therefore, the motor speed may change rapidly, resulting in excessive noise or mechanical stress and other problems. By setting the torque control acceleration and deceleration time, the motor speed can change gently. The torque acceleration and deceleration time corresponds to the time when the torque increases from 0 to d0-03.

In torque control with small torque start, it is not recommended to set torque acceleration and deceleration time; When fast torque response is required, set the acceleration and deceleration time of torque control to 0.00s.

d2 Group - Motor 2 Parameters

The definition and function of the second motor parameters are found in the first motor. For simplicity, the corresponding relationship between the second motor parameters and the first motor parameters is listed below. Users can refer to the corresponding parameter description of the first motor.

d2-00 to d2-37: The numbers, definitions, and functions of parameters P1-00 to P1-37 are the same as those of parameters P1-00 to P1-37. For details, see parameter description of group P1.

d2-38 to d2-66: The corresponding relationship between these parameters and the first motor parameters is shown in the following table:

Motor 2 Parameters	Corresponding to Motor 1 Parameters	Default	Function Description
d2-38	P2-00	30	Speed loop proportional gain 1
d2-39	P2-01	0.50s	Speed loop integral time 1
d2-40	P2-02	5.00Hz	Switchover frequency 1

d2-41	P2-03	20	Speed loop proportional gain 2
d2-42	P2-04	1.00s	Speed loop integral time 2
d2-43	P2-05	10.00Hz	Switchover frequency 2
d2-44	P2-06	100%	Vector control slip compensation gain
d2-45	P2-07	0.015s	SVC torque filter constant
d2-47	P2-09	0	Torque limit source in speed control
d2-48	P2-10	150.0%	Digital setting of torque limit in speed control
d2-49	P2-11	0	Torque limit source in speed control (regenerative)
d2-50	P2-12	150.0%	Digital setting of torque limit in speed control (regenerative)
d2-51	P2-13	2000	Excitation adjustment proportional gain
d2-52	P2-14	1300	Excitation adjustment integral gain
d2-53	P2-15	2000	Torque adjustment proportional gain
d2-54	P2-16	1300	Torque adjustment integral gain
d2-55	P2-17	0	Speed loop integral separation selection
d2-59	P2-21	100%	Max. torque coefficient of field weakening area
d2-60	P2-22	0	Regenerative power limit selection
d2-61	P2-23	0	Regenerative power limit
d2-62	P0-01	2	Motor 2 control mode
d2-63: 0 to 3 corresponds to acceleration and deceleration time 1 to 4		0	Motor 2 acceleration/ deceleration time selection
d2-64	P3-01	Model dependent	Motor 2 torque boost
d2-65	P3-11	40	Motor 2 oscillation suppression gain

d5 Group - Control Optimization Parameters

d5-00	DPWM switchover frequency upper limit	
	5.00 Hz to the maximum frequency	8.00 Hz

Increasing this parameter to the max. frequency will reduce motor audible noise.

d5-01	PWM modulation pattern	
	0 to 1	0

0: Asynchronous modulation

1: Synchronous modulation

When the carrier frequency is less than 10 times the operating frequency, the asynchronous modulated PWM mode will cause current oscillation or high harmonics. In this case, you can set synchronous modulation to suppress current oscillation and harmonics.

d5-02	Dead zone compensation mode selection	
	0 to 1	1

Select whether to compensate the influence of dead zone factor of power device.

0: Disabled

1: Enabled

d5-03	Random PWM depth	
	0 to 10	0

0: Random PWM invalid

1 to 10: Random PWM

If the motor noise is large, you can adjust the setting value (increase 1 each time).

d5-04	Overcurrent fast prevention	
	0 to 1	0

Select whether to enable the per-wave current limiting function.

0: Disabled

1: Enabled

It is suggested that overcurrent fast prevention is disabled (d5-04 = 0) in hoist applications such as crane.

d5-05	Voltage over modulation coefficient	
	100 to 110	105

This parameter indicates boost capacity of maximum voltage of the inverter.

Increasing d5-05 an increase in motor current ripple and an increase in motor heating. Decreasing it will reduce motor current ripple and motor heating. Be aware that this will lower max. loading capacity in motor field weakening area. Adjustment of this parameter is not required normally.

d5-06	Undervoltage threshold	
	330.0V to 420.0V	350.0V

Three-phase 380 to 480V: 330.0 V to 420.0 V. Default: 350.0 V.

One-phase 200 to 240V: 160.0 V to 330.0 V. Default: 200.0 V.

When the bus voltage is lower than the set value of d5-06, the undervoltage fault is reported.

d5-09	Overvoltage threshold	
	650.0V to 820.0V	810.0V

Three-phase 380 to 480V: 650.0 V to 820.0 V. Default: 810.0 V.

One-phase 200 to 240V: 200.0 V to 420.0 V. Default: 400.0 V.

When the bus voltage is lower than the set value of d5-06, the overvoltage fault is reported.

d6 Group - Parameters of AI Curve Setting

d6-00	AI curve 4 min. input	
	-10.00V to d6-02	0.00V
d6-01	Corresponding percentage of AI curve 4 min. input	
	-100.0% to +100.0%	0.0%
d6-02	AI curve 4 inflection 1 input	
	d6-00 to d6-04	3.00V
d6-03	Corresponding percentage of AI curve 4 inflection 1 input	
	-100.0% to +100.0%	30.0%
d6-04	AI curve 4 inflection 2 input	
	d6-02 to d6-06	6.00V
d6-05	Corresponding percentage of AI curve 4 inflection 2 input	
	-100.0% to +100.0%	60.0%
d6-06	AI curve 4 max. input	
	d6-04 to +10.00V	10.00V
d6-07	Corresponding percentage of AI curve 4 max. input	
	-100.0% to +100.0%	100.0%
d6-08	AI curve 5 min. input	
	-10.00V to d6-10	-10.00V
d6-09	Corresponding percentage of AI curve 5 min. input	
	-100.0% to +100.0%	-100.0%
d6-10	AI curve 5 inflection 1 input	
	d6-08 to d6-12	-3.00V
d6-11	Corresponding percentage of AI curve 5 inflection 1 input	
	-100.0% to +100.0%	-30.0%
d6-12	AI curve 5 inflection 2 input	
	d6-10 to d6-14	3.00V
d6-13	Corresponding percentage of AI curve 5 inflection 2 input	
	-100.0% to +100.0%	30.0%

d6-14	AI curve 5 max. input	
	d6-12 to +10.00V	10.00V
d6-15	Corresponding percentage of AI curve 5 max. input	
	-100.0% to +100.0%	100.0%

AI curves 4 and 5 are both 4-point inputs with maximum, minimum, and 2 intermediate points. Parameters d6-00 to d6-07 are related parameters of AI curve 4, and parameters d6-08 to d6-15 are related parameters of AI curve 5. For the curves, see AI Curve 4 and AI Curve 5.

d6-24	Jump point of AI1 input corresponding setting	
	-100.0% to 100.0%	0.0%
d6-25	Jump amplitude of AI1 input corresponding setting	
	0.0% to 100.0%	0.5%
d6-26	Jump point of AI2 input corresponding setting	
	-100.0% to 100.0%	0.0%
d6-27	Jump amplitude of AI2 input corresponding setting	
	0.0% to 100.0%	0.5%
d6-28	Jump point of Panel potentiometer input corresponding setting	
	0 to 100.0%	0.0%
d6-29	Jump amplitude of Panel potentiometer input corresponding setting	
	0.0% to 100.0%	0.5%

Parameters d6-24 to d6-29 are the jump point and jump amplitude input by analog quantities AI1 and AI2 and panel potentiometer.

d9 Group - Control Optimization Parameters

d9-00	Photovoltaic water pump operation mode	
	0 to 2	0

0: Enabled

The main frequency reference value is set by the main frequency reference setting channel selection (P0-03).

1: MPPT control mode 1

The main frequency reference value is calculated from the MPPT mode.

2: MPPT control mode 2

The main frequency reference value is calculated by the MPPT mode, and the frequency can be adjusted by the main frequency reference setting channel selection (P0-03) based on this value.

d9-01	MPPT high operating voltage	
	d9-02 to 1000.0V	Model dependent
d9-02	MPPT low operating voltage	
	0.0V to d9-01	Model dependent

In MPPT control mode 1/2, if the bus voltage (U0-02) is higher than the set value of MPPT high operating voltage (d9-01), it will operate at the max. frequency (P0-10). If it is lower than the set value of MPPT high operating voltage(d9-01), it will operate at the frequency of (bus voltage / MPPT high operating voltage) * Max. frequency. If the bus voltage reaches the MPPT low operating voltage (d9-02), it will operate at minimum operating frequency of PV water pump (d9-06).

d9-03	Undervoltage restart function select	
	0 to 1	0

0: Disabled

1: Enabled

When the running command selection is operating panel (P0-02=0), when d9-03 =1, undervoltage fault occurs in the running state of the device. After the voltage is restored to the non-undervoltage state, the device will restart. When d9-03 =0, the undervoltage fault occurs in the running state of the device, after the voltage is restored to the non-undervoltage state, the equipment is still in the undervoltage state, and the undervoltage fault needs to be reset manually.

d9-04	Undervoltage restart delay time	
	0.0s to 360.0s	10.0s

When the running command selection is operating panel (P0-02=0), when d9-04 =0.0s, the device will automatically start running immediately after the undervoltage state is restored to the non-undervoltage state. When d9-04 is not 0.0s, an undervoltage fault occurs in the running state of the device, at this time, the undervoltage restart delay time will start timing. Within this delay time, the voltage will return to the non-undervoltage state, and the device will cancel reporting the undervoltage fault, and the device will automatically start running after the end of the undervoltage self-start delay time.

d9-05	Restart function Select after power-on	
	0 to 1	0

0: Disabled

1: Enabled

When the running command selection is operating panel (P0-02=0), when d9-05 =1, the device will automatically start and run every time it is powered on. When d9-05 =0, the device does not automatically start and run when it is powered on.

d9-06	Minimum operating frequency of PV water pump	
	0.00Hz to P0-12	0.00Hz
d9-07	The water shortage detection current of photovoltaic water pump corresponds to the proportion of no-load current	
	80.0% to 300.0%	150.0%
d9-08	Water shortage detection time of PV water pump	
	0.0s (No detection); 0.1s to 250.0s	0.0s

In MPPT control mode 1/2, if the inverter runs above the Minimum operating frequency of PV water pump (d9-06), and the output current is less than the motor no-load current (P1-10) * the water shortage detection current of photovoltaic water pump corresponds to the proportion of no-load current (d9-07), after water shortage detection time of PV water pump (d9-08), the inverter reports lack water fault.

d9-09	Photovoltaic water pump bus voltage regulation difference	
	0.0V (No adjustment); 0.1V to 20.0V	1.5V

In MPPT control mode 1/2, when d9-09 =0.0V, the running frequency is updated by calculating the real-time value of bus voltage (U0-02) accurate to two decimal places. When d9-09 is higher than 0.0V, if the difference of real-time change of bus voltage (U0-02) is higher than the difference of voltage regulation of photovoltaic water pump bus, the calculation value of running frequency in real time. If the real-time change value of bus voltage (U0-02) is lower than the voltage adjustment difference value of photovoltaic water pump bus, the calculated running frequency value will be updated the next time it is higher than that.

dC Group - AI/AO Correction Parameters

dC-00	AI1 measured voltage 1	
	-10.00V to 10.000V	2000
dC-01	AI1 displayed voltage 1	
	-10.00V to 10.000V	2020
dC-02	AI1 measured voltage 2	
	-10.00V to 10.000V	8000
dC-03	AI1 displayed voltage 2	
	-10.00V to 10.000V	8000
dC-04	AI2 measured voltage 1	
	-10.00V to 10.000V	2000
dC-05	AI2 displayed voltage 1	
	-10.00V to 10.000V	2020
dC-06	AI2 measured voltage 2	
	-10.00V to 10.000V	8000
dC-07	AI2 displayed voltage 2	
	-10.00V to 10.000V	8050

In field applications with high requirements on analog input, correction can be made as follows:

- 1) Restore factory values, manually modify or restore factory Settings;
- 2) Adjust the input voltage of AI1 to 20% at full scale, and record the measured voltage (measured by multimeter) and display voltage 1 (displayed value on the inverter);
- 3) Adjust the input voltage of AI1 to 80% full scale, and record the measured voltage (measured by multimeter) and display voltage 2 (displayed value on the inverter);
- 4) Input the recorded values to dC-00 to dC-03;
- 5) After calibration, check whether the actual input voltage is consistent with the displayed value of the inverter. The calibration for AI2 and keyboard potentiometers is the same.

dC-08	Panel potentiometer measured voltage 1	
	-15.00V to 15.000V	0
dC-09	Panel potentiometer displayed voltage 1	
	-15.00V to 15.000V	50
dC-10	Panel potentiometer measured voltage 2	
	-15.00V to 15.000V	5000
dC-11	Panel potentiometer displayed voltage 2	
	-15.00V to 15.000V	5000

dC-12	AO1 target voltage 1	
	-20.00V to 20.000V	2000
dC-13	AO1 measured voltage 1	
	-20.00V to 20.000V	3396
dC-14	AO1 target voltage 2	
	-20.00V to 20.000V	8000
dC-15	AO1 measured voltage 2	
	-20.00V to 20.000V	13560

For applications with high requirements on analog output, it can be corrected as follows:

- 1) Restore factory values, manually modify or restore factory Settings;
- 2) Adjust the output voltage of AO1 to 20% at full scale, and record the measured voltage (measured by multimeter) and the expected target voltage 1;
- 3) Adjust the output voltage of AO1 to 80% full scale, and record the measured voltage (measured by multimeter) and the expected target voltage 2;
- 4) Input the recorded values to dC-12 to dC-15;
- 5) After calibration, check whether the actual AO1 output voltage is consistent with the actual expected value.

Note: Before modifying dC-12 to dC-15, record the four parameters and modify them together. If you modify the data of dC-12 and dC-13 (or dC-14 and dC-15) first, and then modify the data of dC-14 and dC-15 (or dC-12 and dC-13) based on the target voltage and the measured voltage of the multimeter, the output voltage is inconsistent with the actual value.

U0 Group - Monitoring Parameters

The U0 group is a read-only monitoring parameter. For details, see Chapter 6.

7. Troubleshooting

7.1 Fault Information and Troubleshooting

Any abnormality occurs during operation, the driver will lock PWM output immediately and enter protection status. Meanwhile, the keypad will display function codes indicating the current fault, and the ALM indicator light will be on. Follow the method described in Table 6-1 to check the fault cause and conduct according actions. If the problem remains, contact us directly.

Table 7-1 Fault Diagnosis and Troubleshooting

Fault display	Fault Name	Possible Cause	Solution
-F02-	Overcurrent during acceleration	A grounding fault or short circuit exists in the output circuit.	Check whether short-circuit occurs on the motor, motor cable, or contactor.
		The control mode is SVC or FVC but motor auto-tuning is not performed.	Set motor parameters according to the motor nameplate and perform motor auto-tuning.
		The acceleration time is too short.	Increase the acceleration time.
		The overcurrent stall prevention parameters are set improperly.	Ensure that current limit is enabled (P3-19 = 1). The setting of P3-18 (Current limit level) is too large. Adjust it between 120% and 150%. The setting of P3-20 (Current limit gain) is too small. Adjust it between 20 and 40.
		Customized torque boost or V/F curve is not appropriate.	Adjust the customized torque boost or V/ F curve.
		The spinning motor is started.	Enable the catching a spinning motor function or start the motor after it stops.
		The inverter suffers external interference.	View historical fault records. If the current value is far from the overcurrent level, find the interference source. If an external interference does not exist, the drive board or hall device may be faulty.
-F03-	Overcurrent during deceleration	A grounding fault or short circuit exists in the output circuit.	Check whether short-circuit occurs on the motor, motor cable, or contactor.
		The control mode is SVC or FVC but motor auto-tuning is not performed.	Set the motor parameters according to the motor nameplate and perform motor auto-tuning.
		The deceleration time is too short.	Increase the deceleration time.

		The overcurrent stall prevention parameters are set improperly.	Ensure that current limit is enabled (P3-19 = 1). The setting of P3-18 (Current limit level) is too large. Adjust it between 120% and 150%. The setting of P3-20 (Current limit gain) is too small. Adjust it between 20 and 40.
		The braking unit and braking resistor are not installed.	Install the braking unit and braking resistor.
		The inverter suffers external interference.	View historical fault records. If the current value is far from the overcurrent level, find the interference source. If an external interference does not exist, the drive board or hall device may be faulty.
-F04-	Overcurrent at constant speed	A grounding fault or short circuit exists in the output circuit.	Check whether short-circuit occurs on the motor, motor cable, or contactor.
		The control mode is SVC or FVC but motor auto-tuning is not performed.	Set motor parameters according to the motor nameplate and perform motor auto-tuning.
		The overcurrent stall prevention parameters are set improperly.	Ensure that current limit is enabled (P3-19 = 1). The setting of P3-18 (Current limit level) is too large. Adjust it between 120% and 150%. The setting of P3-20 (Current limit gain) is too small. Adjust it between 20 and 40.
		The inverter power class is small.	If the output current exceeds the rated motor current or rated output current of the inverter during stable running, replace an inverter of larger power class.
		The inverter suffers external interference.	View historical fault records. If the current value is far from the overcurrent level, find the interference source. If an external interference does not exist, the drive board or hall device may be faulty.
-F05-	Overvoltage during acceleration	The input voltage is too high.	Adjust the input voltage to normal range.
		An external force drives the motor during acceleration.	Cancel the external force or install a braking resistor.
		The overvoltage stall prevention parameters are set improperly.	Ensure that the voltage limit function is enabled (P3-23 = 1). The setting of P3-22 (Voltage limit) is too large. Adjust it between 700 V and 770 V. The setting of P3-24(Frequency gain for voltage limit) is too small. Adjust it between 30 and 50.

		The braking unit and braking resistor are not installed.	Install the braking unit and braking resistor.
		The acceleration time is too short.	Increase the acceleration time.
-F06-	Overvoltage during deceleration	The overvoltage stall prevention parameters are set improperly.	Ensure that the voltage limit function is enabled (P3-23 = 1). The setting of P3-22 (Voltage limit) is too large. Adjust it between 700 V and 770 V. The setting of P3-24 (Frequency gain for voltage limit) is too small. Adjust it between 30 and 50.
		An external force drives the motor during deceleration.	Cancel the external force or install a braking resistor.
		The deceleration time is too short.	Increase the deceleration time.
		The braking unit and braking resistor are not installed.	Install the braking unit and braking resistor.
-F07-	Overvoltage at constant speed	The overvoltage stall prevention parameters are set improperly.	Ensure that the voltage limit function is enabled (P3-23 = 1). The setting of P3-22 (Voltage limit) is too large. Adjust it between 700 V and 770 V. The setting of P3-24 (Frequency gain for voltage limit) is too small. Adjust it between 30 and 50. The setting of P3-26 (Frequency rise threshold during voltage limit) is too small. Adjust it between 5 Hz and 20 Hz.
		An external force drives the motor during acceleration.	Cancel the external force or install a braking resistor.
-F08-	Pre-charge power fault	The bus voltage fluctuates around the undervoltage threshold continuously.	Adjust the voltage to the range required by the specification.
-F09-	Undervoltage	An instantaneous power failure occurs.	Enable the power dip ride through function.
		The inverter's input voltage is not within the permissible range.	Adjust the voltage to the normal range.
		The bus voltage is abnormal.	Seek technical support.
		The rectifier bridge, pre-charge resistor, drive board, or control board are abnormal.	Seek technical support.

-F10-	Inverter overload	The load is too heavy or locked-rotor occurs on the motor.	Reduce the load or check motor and mechanical conditions.
		The inverter power class is small.	Replace an inverter of larger power class.
-F11-	Motor overload	P9-01 (Motor overload protection gain) is set improperly.	Set P9-01 (Motor overload protection gain) correctly.
-F12-	Input phase loss	Input phase loss occurs.	Eliminate faults in external circuits.
		The drive board, lightning protection board, main control board, or rectifier bridge is abnormal.	Seek technical support.
-F13-	Output phase loss	The motor is faulty.	Check and ensure that the motor is without open circuit.
		The cable connecting the inverter and the motor is abnormal.	Eliminate external faults.
		The inverter's three-phase outputs are unbalanced when the motor is running.	Check whether the motor three-phase winding is normal.
		The drive board or the IGBT is abnormal.	Seek technical support.
-F14-	IGBT overheat	The ambient temperature is too high.	Lower the ambient temperature.
		The ventilation is clogged.	Clean the ventilation.
		The fan is damaged.	Replace the cooling fan.
		The thermistor of IGBT is damaged.	Replace the thermistor.
-F15-	External fault	The IGBT is damaged.	Replace the IGBT.
		An external fault signal is input using X terminal.	Eliminate external faults, and confirm that the mechanical condition allows restart (P8-18) and reset the operation.
-F16-	Communication fault	The host controller is in abnormal state.	Check the cable of host controller.
		The communication cable is abnormal.	Check the communication cables.
		Communication parameters in group Pd are set improperly.	Set communication parameters in group Pd properly.
		If the fault still exists after all the preceding checkings are done, restore the default settings.	
-F17-	Contactor fault	The drive board and power supply are abnormal.	Replace the drive board or power supply board.
		The contactor is abnormal.	Replace the contactor.
		The lightning protection board is abnormal.	Replace the lightning protection board.

-F18-	Current detection fault	The hall is abnormal.	Replace the hall element.
		The drive board is abnormal.	Replace the drive board.
-F19-	Motor auto-tuning fault	Motor parameters are not set according to the nameplate.	Set motor parameters correctly according to the nameplate.
		Motor auto-tuning timeout.	Check whether the inverter and motor are connected correctly.
		The encoder is abnormal.	Check whether P1-27 (Encoder pulses per revolution) is set correctly. Check whether signal lines of the encoder are connected correctly and securely.
-F20-	Encoder fault	The encoder is not matched.	Set the encoder type correctly.
		The encoder wiring is incorrect.	Check the PG card power supply and phase sequence.
		The encoder is damaged.	Replace the encoder.
		The PG card is abnormal.	Replace the PG card.
-F21-	EEPROM read-write fault	The EEPROM chip is damaged.	Replace the main control board.
-F23-	Short circuit to ground	The motor is short-circuited to the ground.	Replace the cable or motor.
-F26-	Accumulative running time reached	The accumulative running time reached the set value.	Clear the record by parameter initialization.
-F27-	User-defined fault 1	The signal of user-defined fault 1 is input through the multi-functional terminal X.	Perform the reset operation.
-F28-	User-defined fault 2	The signal of user-defined fault 2 is input through the multi-functional terminal X.	Perform the reset operation.
-F29-	Accumulative power-on time reached	The accumulative power-on time reached the set value.	Clear the record by parameter initialization.
-F30-	Load loss	The operation current of the inverter is smaller than P9-64 (Load loss detection level).	Check whether the load is disconnected or ensure that P9-64 (Load loss detection level) and P9-65 (Load loss detection time) are set based on the actual conditions.
-F31-	PID Feedback loss	PID feedback is smaller than PA-26 (Detection level of PID feedback loss).	Check the PID feedback signal or set PA-26 (Detection level of PID feedback loss) correctly.
-F40-	Pulse-by-pulse current limit fault	The load is too heavy or locked-rotor occurs on the motor.	Reduce the load or check motor and mechanical conditions.
		The inverter power class is small.	Replace an inverter of larger power class.

-F41-	Motor switchover fault during running	Motor switchover is performed using a terminal during running of the inverter.	Perform motor switchover after the inverter stops.
-F42-	Speed error	Encoder parameters are set improperly.	Set encoder parameters properly.
		Motor auto-tuning is not performed.	Perform motor auto-tuning.
		P9-69 (Detection level of speed error) and P9-70 (Detection time of speed error) are set incorrectly.	Set P9-69 (Detection level of speed error) and P9-70 (Detection time of speed error) correctly based on actual condition.
-F43-	Motor overspeed	Encoder parameters are set improperly.	Set encoder parameters properly.
		Motor auto-tuning is not performed.	Perform motor auto-tuning.
		P9-67 (Overspeed detection level) and P9-68 (Overspeed detection time) are set incorrectly.	Set P9-67 (Overspeed detection level) and P9-68 (Overspeed detection time) correctly based on the actual situation.
-F55-	Motor overheat	The slave machine is faulty. Check the slave machine.	Rectify the fault according to the slave machine fault code.
-F64-	Modules overcurrent during acceleration	The same as the -F02 -.	
-F65-	Modules overcurrent during deceleration	The same as the -F03 -.	
-F66-	Modules overcurrent at constant speed	The same as the -F04 -.	
-F70-	Lack water	Water shortage fault in MPPT control mode 1/2.	Adjust the minimum operating frequency of PV water pump (d9-06).
-F71-	Rectifier bridge overheat	The ambient temperature is too high.	Lower the ambient temperature.
		The rectifier bridge is damaged.	Seek technical support.
SLEEP	hibernating state	hibernating state when the PID function is enabled	Non-fault state, automatic operation when the pressure feedback value decreases or the set pressure rises.
H-H-O	water shortage state	Water shortage fault when the PID function is enabled	The feedback pressure is small, and the display will disappear automatically when the water supply is restored. User can set parameters to mask this alarm.

Appendix :

A. Modbus Communication Protocol

B.1 Modbus Communication Protocol

The drive provides RS485 communication interface and supports Modbus-RTU communication protocol so that the user can implement centralized control, such as setting running commands and function codes, and reading running status and fault information of the inverter, by using a PC or PLC.

This protocol defines content and format of transmitted messages during serial communication, including master polling (or broadcasting) format and master coding method (function code for the action, transmission data, and error check). The slave uses the same structure in response, including action confirmation, data returning and error check. If an error occurs when the slave receives a message, or the slave cannot complete the action required by the master, the slave returns a fault message as a response to the master.

A.1.1 Bus Structure

The inverter is connected to a "single-master multi-slave" PC/PLC control network with RS485 bus. The RS485 topology is a single-master multi-slave system. The system consists of a single master and multiple slaves. In the network, each communication device has a unique slave address. A device is the master (can be a PC, a PLC or an HMI) and initiates communication to perform parameter read or write operations on slaves. The other devices (slaves) provide data to respond to query or operations from the master. At the same moment, either the master or the slave transmits data and the other can only receive data.

The address range of the slaves is 1 to 247, and 0 is broadcast address. A slave address must be unique in the network. The asynchronous serial and half-duplex transmission mode is used. During asynchronous serial communication, data is sent frame by frame in the form of message. In Modbus-RTU protocol, an interval of at least 3.5-byte time marks the end of the previous message. A new message starts to be sent after this interval.

RS485 communication transmission mode is the use of the asynchronous serial and half-duplex transmission mode. During asynchronous serial communication, data is sent frame by frame in the form of message. In Modbus-RTU protocol, an interval of at least 3.5-byte time marks the end of the previous message. A new message starts to be sent after this interval.

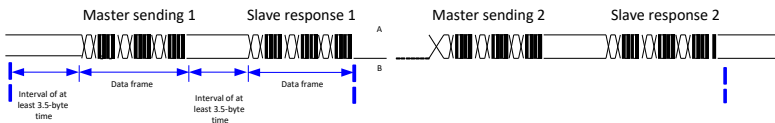

The communication protocol used by the drive is the Modbus-RTU slave communication protocol, which allows the drive to provide data to respond to "query/command" from the master or execute the action according to "query/command" from the master.

The master can be a PC, an industrial device, or a PLC. The master can communicate with a single slave or send broadcast messages to all slaves. When the master communicates with a single slave, the slave needs to return a message (response) to "query/command" from the master. For a broadcast message sent by the master, the slaves need not return a response.

A.1.2 Data Format

The drive supports reading and writing of word-type parameters only. Reading command is 0x03 and writing command is 0x06. It does not support reading and writing of bytes or bits.

The Modbus-RTU protocol communication data format of the drive is as follows:

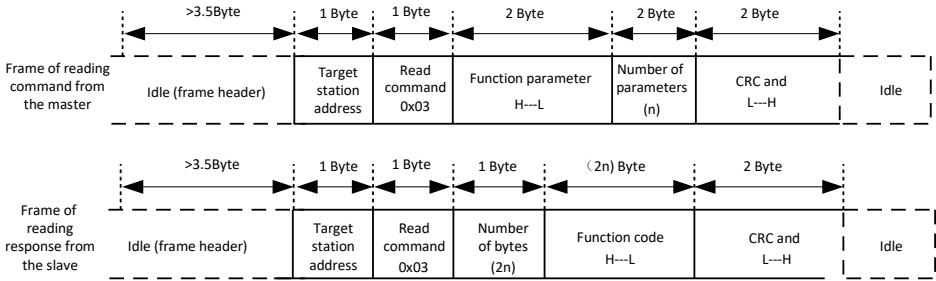

In theory, host computer can read several consecutive parameters (n can reach up to 12) but the last parameter it reads must not jump to the next parameter group. Otherwise, an error occurs on response.

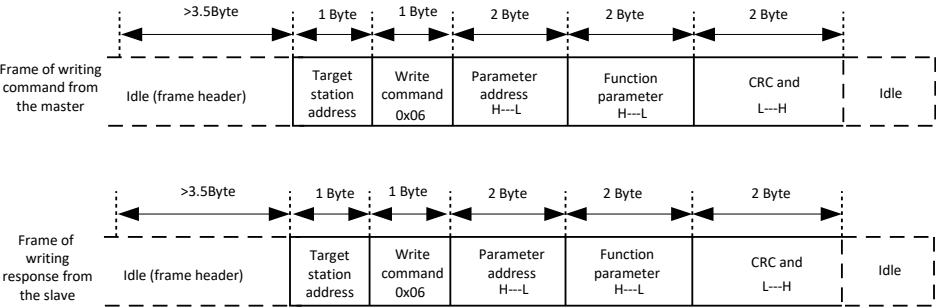

If the slave detects a communication frame error or reading/writing failure is caused by other reasons, an error frame will be returned as follows:

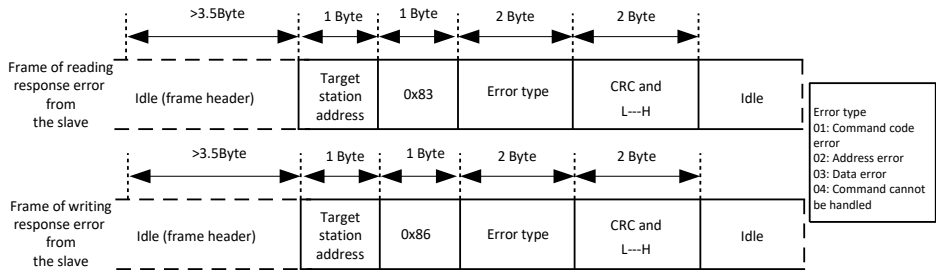

The frame format is described in the following table.

Frame header (START)	Greater than the 3.5-byte transmission idle time
Slave address(ADR)	Communication address : 1 to 247 0: Broadcast address
Command code (CMD)	03:Read slave parameters 06: Write slave parameters

Function code address (H)	It is the internal parameter address of the inverter, expressed in hexadecimal format. The parameters include functional parameters and non-functional parameters (running status and running command). During transmission, low-order bytes follow the high-order bytes.
Function code address (L)	
Number of function codes (H)	It is the number of function codes read by this frame. If it is 1, it indicates that one function code is read. During transmission, low bytes follow high bytes. In the present protocol, only one function code is read once, and this field is unavailable.
Number of function codes (L)	
Data (H)	It is the response data or data to be written. During transmission, low-order bytes follow the high-order bytes.
Data (L)	
CRC CHK high bytes	It is the detection value (CRC16 verification value). During transmission, low-order bytes follow the high-order bytes.
CRC CHK low bytes	
END	It is 3.5-byte transmission time.

CRC Check

In Modbus-RTU mode, a message includes a CRC-based error-check field. The CRC field checks content of entire message. The CRC field is two bytes, containing a 16-bit binary value. The CRC field is calculated by transmitting device, and then added to message. The receiving device recalculates a CRC value after receiving message, and compares the calculated value with the CRC value in the received CRC field.

The CRC is first stored to 0xFFFF. Then a procedure is invoked to process the successive 8-bit byte in the message and the value in the register. Only the eight bits in each character are used for the CRC. The start bit, stop bit and the parity bit do not apply to the CRC.

During generation of the CRC, each eight-bit character is in exclusive-OR (XOR) with the content in the register. Then the result is shifted in the direction of the least significant bit (LSB), with a zero filled into the most significant bit (MSB) position. The LSB is extracted and examined. If the LSB was a 1, the register then performs XOR with a preset value. If the LSB was a 0, no XOR is performed. This process is repeated until eight shifts have been performed. After the last (eighth) shift, the next eight-bit byte is in XOR with the register's current value, and the process repeats for eight more shifts as described above. The final value of the register, after all the bytes of the message have been applied, is the CRC value.

The CRC is added to the message from the low-order byte followed by the high-order byte. The CRC simple function is as follows:

B.2 Parameter address identifies rules and read/write examples

A.2.1 Parameter data

Read and Written Parameters

Parameter group number and label number are used as parameter addresses to represent rules:

High-order bytes: P0 to PP (groups P), d0 to dC (groups d), 70 to 7F (group U)

Low-order bytes: 00 to FF

For example, to read parameter P3-12, communication address of P3-12 is expressed as 0xF30C.

Note:

Group PF: They are factory parameters. The parameters cannot be read or changed.

Group U: These parameters can only be read.

Some parameters cannot be modified when the inverter is running. Some parameter cannot be modified regardless of status of the inverter. In addition, pay attention to setting range, unit and description of parameters when modifying them.

Parameter Group	Visited Address	Parameter Address in RAM
P0 to PE	0xF000 to 0xFEFF	0x0000 to 0x0EFF
d0 to dC	0xA000 to 0xACFF	0x4000 to 0x4CFF
U0	0x7000 to 0x70FF	-

Note:

Frequent storage to the EEPROM reduces its service life. Therefore, in communication mode, users can change values of certain parameters in RAM rather than storing the setting.

For groups P parameters, users only need to change high order F of the function code.

For groups d parameters, users only need to change high order A of the function code address to 4.

For example, if function code P3-12 is not stored into EEPROM, the address is expressed as 030C; if function code d0-05 is not stored into EEPROM, the address is expressed as 4005.

This address indicates that it can only write RAM, but cannot read RAM. It is an invalid address when reading RAM.

A.2.2 Stop/RUN Parameters

Para. Address	Description	Para. Address	Description
1000H	Communication setting value (Decimal): -10000 to 10000	1010H	PID reference
1001H	Running frequency	1011H	PID feedback
1002H	Bus voltage	1012H	PLC process
1003H	Output voltage	1013H	Pulse input frequency, unit: 0.01 kHz
1004H	Output current	1014H	Feedback speed, unit 0.1Hz
1005H	Output power	1015H	Remaining running time
1006H	Output torque	1016H	AI1 voltage before correction
1007H	Running speed	1017H	AI2 voltage before correction
1008H	X input indication	1018H	Panel potentiometer voltage before correction
1009H	digital output terminal output indication	1019H	Linear speed
100AH	AI1 voltage	101AH	Current power-on time
100BH	AI2 voltage	101BH	Current running time
100CH	Panel potentiometer voltage	101CH	Pulse input frequency, unit 1Hz
100DH	Counting value input	101DH	Communication reference
100EH	Length value input	101EH	Actual feedback speed
100FH	Load speed	101FH	Main frequency X reference display
-	-	1020H	Auxiliary frequency Y reference display

Note:

Communication setting value indicates percentage: 10000 corresponds to 100.00%, and -10000 corresponds to -100.00%.

With regard to frequency, communication reference is a percentage of P0-10 (maximum frequency).

With regard to torque, communication reference is a percentage of P2-10 and d2-48 (corresponding to motor 1 and motor 2, respectively).

A.2.3 State data

a)U Group parameters Monitoring parameters

For the description of monitoring data in group U, see Chapter 6 Function Parameter Table and Chapter 7 Parameter Description. The IP addresses are defined as follows: U0 to UF: the highest 16 digits are 70 to 7F, and the lower 16 digits are the serial numbers of monitoring parameters in the group. For example, U0-11:700BH.

b)Frequency Converter Fault Description (Read only)

When the communication reads the fault description of the inverter, the communication address is fixed at 8000H. By reading the address data, the upper computer can obtain the fault code of the current inverter. For the fault code description, see the parameter content of P9-14 in Chapter 7 Parameter Description.

Inverter fault description

AC Drive Fault Address	AC Drive Fault Information	
8000H	0000: No fault	0007: Overvoltage at constant speed
	0001: Reserved	0008: Buffer resistor overload
	0002 Overcurrent during acceleration	0009: Undervoltage
	0003: Overcurrent during deceleration	000A: Inverter overload

0004: Overcurrent at constant speed	000B: Motor overload
0005: Overvoltage during acceleration	000C: Power input phase loss
0006: Overvoltage during deceleration	000D: Power output phase loss
000E: IGBT overheat	001D: Accumulative power-on time Reached
000F: External fault	001E: Load lost
0010: Communication fault	001F: PID feedback lost during running
0011: Contactor fault	0028: Fast current limit timeout
0012: Current detection fault	0029: Motor switchover error during running
0013: Motor auto-tuning fault	002A: Too large speed deviation
0014: Encoder/PG card fault	002B: Motor over-speed
0015: Parameter read and write fault	002D: Reserved
0016: Inverter hardware fault	005A: Incorrect setting of PPR of the encoder
0017: Motor short circuited to ground	005B: Reserved
0018: Reserved	005C: Reserved
0019: Reserved	005E: Speed feedback error
001A: Accumulative running time reached	
001B: User-defined fault 1	
001C: User-defined fault 2	

c) Inverter running Status (read only)

When the communication reads the running state of the inverter, the communication address is fixed at 3000H. By reading the address data, the upper computer can obtain the current running state information of the inverter, which is defined as follows:

Command Word Address	Command Word Function
3000H	0001: Forward RUN
	0002: Reverse RUN
	0003: Stop

A.2.4 Control parameters

a) Control command input to inverter (write-only)

When P0-02=2, namely communication control, the upper computer can control the start and stop of the inverter and other related commands through this communication address. The control commands are defined as follows:

Command Word Address	Command Word Function
2000H	0001: Forward run
	0002: Reverse run
	0003: Forward jog
	0004: Reverse jog
	0005: Coast to stop
	0006: Decelerate to stop
	0007: Fault reset

b)Communication set value

Communication set value is mainly used for frequency source, torque upper limit source, V/F separation voltage source, PID given source, PID feedback source and other selected as the given data for communication timing. Its communication address is 1000H. When the upper computer sets the communication address value, its data range is -1000 to 1000, corresponding to the relative given value -100.0% to 100.0%.

c)Digital output terminal control (write-only)

When the digital output control function is set to 20: in communication control, the upper computer can control the digital output terminal of the inverter through this communication address, which is defined as follows:

Command Address	Command Content
2001H	BIT0: reserved BIT1: reserved BIT2: RELAY1 control BIT3: RELAY2 control BIT4: FMR control BIT5: reserved BIT6: reserved BIT7: reserved BIT8: reserved BIT9: reserved

d)Analog output AO1 and high speed pulse output FMP control (write only)

When the output function of AO1, the analog output, and FMP, the high-speed pulse output, is set to 12: communication setting, the upper computer can control the analog output and high-speed pulse output of the inverter through this communication address, as defined below:

●**AO1 control (write-only)**

Command Address	Command Content
2002H	0 to 7FFF indicates 0% to 100%.

●**Pulse output control (write-only)**

Command Address	Command Content
2004H	0 to 7FFF indicates 0% to 100%.

B. LCD Panel Operation Instructions

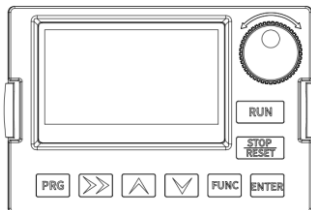

B.1 Panel operation



B.1.1 Panel introduction

Function code setting/modification, parameter uploading and downloading, working status monitoring (start, stop) and other operations can be carried out through the LCD panel.

B.1.2 Key instruction

Key	Name	Function Description
PRG	Programming key	Enter or exit Level I menu. Return to the previous menu.
ENTER	Enter key	Enter each level of menu interface. Confirm displayed parameter setting.
	Increase key	Increments of display menu and list selections, scrolls text pages, enters password or parameter values.
	Decrease key	Decrement of display menu and list selections, scrolls text pages, enters password or parameter values.
	Shift key	Page toggle to display menu and list selections. Move the cursor left in parameter editing.
RUN	Run key	Start the inverter when using the operating panel control mode.
STOP/RESET	Stop/Reset key	Stop the inverter when the device is in the running status. Perform a reset operation when the device is in the fault status.
FUNC	Function key	Perform a function switchover as defined by the setting of P7-01.

B.1.3 Parameter setting

The following takes setting the digital setting frequency as an example to introduce the parameter setting method of the LCD panel of the converter.

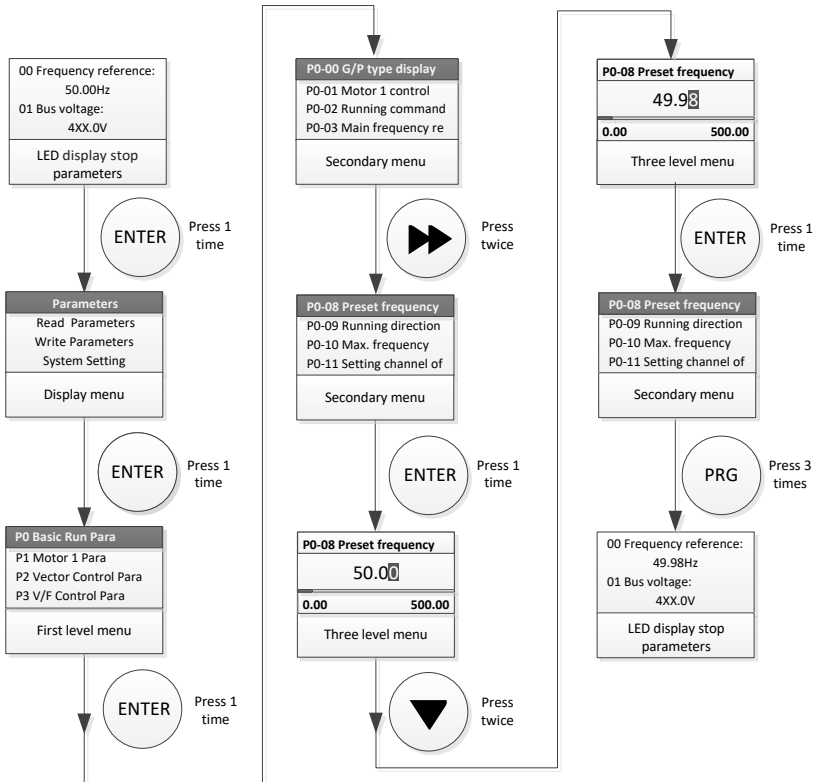

B.1.4 Language setting

To change language: Open " Display Menu" → "System Setting" → "Language".

C. Warranty Agreement

1 This product warranty period is twelve months (based on the fuselage bar type code information), during the warranty period, according to the normal use of the instructions, the product failure or damage, our company is responsible for free repair.

1 本产品保修期为十二个月（以机身条形码信息为准），保修期内按照使用说明书正常使用情况下，产品发生故障或损坏，我公司负责免费维修。

2 Within the warranty period, due to the following causes of damage, will receive a certain maintenance costs:

2 保修期内，因以下原因导致损坏，将收取一定的维修费用：

A, Machine damage due to errors in use and self repair and reconstruction without authorization;

A、因使用上的错误及自行擅自修理、改造而导致的机器损坏；

B, Damage caused by fire, flood, voltage anomaly, other natural disasters and two disasters;

B、由于火灾、水灾、电压异常、其它天灾及二次灾害等造成的机器损坏；

C, hardware damage caused by artificial falling and transportation after purchase;

C、购买后由于人为摔落及运输导致的硬件损坏；

D, Damage to the machine caused by the operation of the user's manual supplied by our company;

D、不按我司提供的用户手册操作导致的机器损坏；

E, Malfunction and damage caused by obstacles outside the machine (such as external equipment factors);

E、因机器以外的障碍（如外部设备因素）而导致的故障及损坏；

3 When the product failure or damage, please correct and detailed fill in "product warranty card" in the content.

3 产品发生故障或损坏时，请您正确、详细的填写《产品保修卡》中的各项内容。

4 The maintenance fee shall be charged according to the latest maintenance price list of our company.

4 维修费用的收取，一律按照我公司最新调整的《维修价目表》为准。

5 The warranty cards in general will not be reissued, honesty please keep this card and show it to the maintenance personnel in maintenance.

5 本保修卡在一般情况下不予补发，诚请您务必保留此卡，并在保修时出示给维修人员。

6 If there is any problem in the service process, please contact our agent or our company in time.

6 在服务过程中如有问题，请及时与我司代理商或我公司联系。

Product Warranty Card

The customer information	Company Address:	
	Company Name:	Contact Name:
		Telephone Number:
Product information	Model Number:	
	Barcode of The Body (pasted here) :	
	Agent Name:	
Fault information	(Maintenance Time and Content) :	
	Maintenance Personnel:	